

ekinex

CONTROL YOUR LIVING SPACE



Application Manual

KNX fan-coil actuators/controllers

EK-HA1-TP

EK-HB1-TP

EK-HC1-TP

Contents

1	Scope of the document.....	5
2	Product description.....	6
2.1	Applications for air terminals.....	6
2.2	Technical characteristics.....	7
3	Switching, display and connection elements.....	8
4	Configuration.....	10
5	Commissioning.....	10
6	Function description.....	11
6.1	Switching on.....	11
6.2	Offline operation.....	11
6.2.1	Operation with bus power only.....	11
6.2.2	Operation with auxiliary power only.....	11
6.3	Manual operation.....	12
6.3.1	Output status when mode changes.....	12
6.3.2	Manual mode activation.....	12
6.4	Online operation.....	14
6.4.1	Software working cycle.....	14
6.4.2	State variables (communication objects).....	14
6.5	Applications.....	14
6.6	Operation as actuator.....	14
6.6.1	Choosing the control variable type.....	14
6.6.2	Control variable timeout alarm.....	15
6.7	Operation as controller and actuator.....	15
6.7.1	Control algorithms.....	15
6.7.1.1	1-2-3 speed ON/OFF control.....	15
6.7.1.2	Proportional control with continuous output.....	16
6.7.1.3	Proportional-integral control with continuous output.....	16
6.7.2	Setpoint management.....	17
6.7.3	Operating modes.....	18
6.7.4	Heating/cooling switch over.....	18
6.7.5	Temperature control alarm.....	20
6.8	External inputs and inputs from bus.....	21
6.8.1	Room temperature or return air temperature for control.....	21
6.8.2	External climate compensation.....	21
6.8.3	Heat exchange coil temperature for hot and cold start.....	21
6.8.4	(2-sensor) antistratification temperature.....	21
6.8.5	Water intake temperature for automatic heating/cooling switch over.....	22
6.8.6	Generic temperature acquisition.....	22
6.8.7	Window contacts.....	22
6.8.8	Presence sensors.....	22
6.9	Drip tray control.....	25
6.10	Filter monitoring.....	25
6.11	Valve protection.....	25
6.12	Auxiliary output.....	25

7	Application program for ETS	27
7.1	About EK-HX1-TP	27
7.2	General	28
7.3	Inputs	31
7.4	External sensors (from bus).....	33
7.5	Ventilation	35
7.6	Heating valve	40
7.7	Cooling valve	41
7.8	Heating/cooling valve.....	42
7.9	Auxiliary relays.....	43
7.10	Drip tray level control	44
7.11	Filter monitoring	45
7.12	Feedback (EK-HC1-TP only)	46
7.13	Temperature control.....	48
7.13.1	Settings	48
7.13.1.1	Monitoring and remote command of the conduction mode.....	50
7.13.1.2	Remote operative mode modification	50
7.13.2	Heating.....	51
7.13.2.1	Remote Setpoint modification	53
7.13.2.2	Output manual command.....	54
7.13.3	Cooling	55
7.13.4	External temperature compensation	58
7.13.5	Ventilation.....	60
7.13.5.1	Remote fan speed modification.....	66
7.13.6	Windows contacts	67
7.13.7	Presence sensors	68
7.14	Logic functions	69
8	Appendix.....	71
8.1	List of communications objects.....	71
8.1.1	Communications object for EK-HA1-TP and EK-HB1-TP.....	71
8.1.2	Communications object for EK-HC1-TP	74
8.2	Alarms	77
8.3	Application examples	78
9	Warnings.....	80
10	Other information.....	80

Revision	Modifications	Date	Drafted	Revised
4.0	New features for HC1 as a general purpose controller. Added par. 7.12 and modified par. 7.5 and 7.13.5 (ventilation).	27/03/2024	G. Schiochet	C. Baldini
3.1	Changes to par. 6.7, explaining the heating/cooling status immediately after the application download	26/02/2019	G. Schiochet	G. Colombo
3.00	ETS application version: for EK-HC1-TP: VER 2.00 Modified features: ⇒ <i>Heating/cooling status out</i> CO always visible and updated to power on when plant mode is active.	20/03/2017	F. Deantoni	G. Colombo
2.00	ETS application version: for EK-HA1-TP: VER 2.00 for EK-HB1-TP: VER 2.00 for EK-HC1-TP: VER 1.00 Modified features: ⇒ <i>Heating/cooling status out</i> and <i>Heating/cooling status in</i> communication objects (<i>more enhanced management</i>)	20/06/2016	F. Deantoni	G. Colombo
1.01	New alarms, page 75	08/04/2016	F. Deantoni	G. Colombo
1.00	Emission	18/03/2016	F. Deantoni	G. Colombo

1 Scope of the document

This application manual describes application details for the A1.0 release of the ekinex® fan-coil actuators/controllers EK-Hx1-TP.

The document is aimed at the system configurator as a description and reference of device features and application programming. For installation, mechanical and electrical details of the device please refer to the technical description datasheet.

Application manual and application programs for ETS are available for download at www.ekinex.com.

Item	File name (## = release)	Version	Device rel.	Update
Product datasheet	STEKHx1TP##_IT.pdf	EK-HA1-TP, EK-HB1-TP, EK-HC1-TP	A1.0	04 / 2024
Application manual	MAEKHx1TP##_IT.pdf			
Application program	APEKHA1TP##_knxprod			
	APEKHB1TP##_knxprod	EK-HB1-TP		
	APEKHC1TP##_knxprod	EK-HC1-TP		

2 Product description

The ekinex® fan-coil actuator/controller is a 35mm rail mounting KNX device for fan-coils, air convectors and fan units control, suitable for room ventilation, heating and cooling applications.

The device can work as a simple actuator, in combination with an external KNX controller (e.g. a room thermostat or an ekinex® Touch&See unit), or as an actual room temperature controller, measuring the room temperature by means of a different KNX device (e.g. an ekinex® pushbutton unit) or a traditional NTC temperature sensor connected to an analog input, internally calculating the regulation value and performing the corresponding actuation.

The device is equipped with an integrated KNX communication module and is suitable for 35mm rail mounting, according to EN 60715. It is powered by the KNX bus line with a 30 VDC SELV voltage and the supply of the power side is supplied by electric power distribution (230 Vac, 50-60 Hz).

The supply includes, inside the box:

- one device;
- 1 KNX terminal block for the connection of the bus line;
- an instruction sheet.

2.1 Applications for air terminals

Fan-coils are forced-convection terminal units which are very common in room heating and cooling applications. The machine is essentially constituted by one or two heat exchange coils supplied with heat transfer fluid (cooled during summer and heated during winter), one fan group to force the cooled or heated air inside the environment and one intercept valves for each idraulic circuit. The heat transfer unit that supplies the coil is produced by a thermic plant and is distributed to the fan-coil units by means of an idraulic distribution network. In order to create the comfort conditions inside the enviroment based on the desired setpoint, the motorized actuators of the intercept valves are opened or closed and the air flow entering the enviroment is controlled (after having touched the coil surface) by means of the rotation speed of a fan unit (three steps or continuous regulation). While cooling, according to the supply temperature of the heat transfer fluid, drip water can appear on the coil surface; this water is collected by a proper water basin and then disposed by gravity or by a discharge pump. During system design, fan-coil units are sized with enough power to handle the thermal loads of the enviroments where they are installed; in parallel, the temperature of the heat transfer fluid to be produced of one or both working seasons.



The regulation with KNX devices, though properly configured and commissioned, cannot replace in any way the wrong sizing of thermal generators, distribution network and room terminals.

According to its version, the actuator/regulator can control fan groups with 3-speed motors and brushless motors equipped with inverters. It can be used to control fan-coil units connected to systems with different purpose, idraulic distribution and heating/cooling change over:

- 2-pipe heating;
- 2-pipe cooling;
- 2-pipe both heating and cooling with centralized change over via bus;
- 2-pipe both heating and cooling with local change over via temperature sensor installed on the pipe which conveys the fluid to the heat exchange coil;
- 4-pipe both heating and cooling with centralized change over via bus;

- 4-pipe both heating and cooling with automatic change over based on environment's conditions (room temperature or user defined comfort zone).

In fan control applications, the regulation of the intercept valves of the heat exchange coils is not foreseen: those outputs are available for purposes other than temperature control (e.g. an ON/OFF light control) and are controlled by 1-bit communication objects.

Moreover, the application for conveying units allows performing an ON/OFF control with an external controller or an ON/OFF and PWM (pulse width modulation) with the integrated controller for terminals equipped with air-water heat exchange coils whose constant air flow is controlled by an independent primary air treatment machine. In this kind of applications, the 3 outputs for 3-speed control and/or the 0 ... 10V output are available for purposes other than temperature control and are controlled by communication objects.

2.2 Technical characteristics

	EK-HA1-TP	EK-HB1-TP	EK-HC1-TP
Electrical characteristics			
30 Vdc power supply from bus	X	X	X
Auxiliary 230 Vac 50/60 Hz power supply	X	X	X
Freely programmable analog or binary inputs	2	2	3
Relay outputs for heat exchange coils command	1	1	2
Relay outputs for fan command	3	-	3
0-10 Vdc output	-	1	1
Membrane keyboard to manually command outputs	-	-	X
Operating ranges			
Applications with 2-pipe idraulic distribution	X	X	X
Applications with 4-pipe idraulic distribution	-	-	X
Second stage command with electric coil	-	-	X
Operation as actuator	X	X	X
Operation with integrated temperature controller	X	X	X
Configuration of unused outputs for other purposes	X	X	X
Control algorithms			
Heat exchange coil(s): ON/OFF control with hysteresis	X	X	X
Heat exchange coil(s): PWM (pulse width modulation)	X	X	X
Fan: ON/OFF 1-3 speed control	X	X	X
Fan: Proportional control with continuous output	-	X	X
Fan: Proportional-integral control with continuous output	-	X	X

3 Switching, display and connection elements

The front side of the most complete version of the device, EK-HC1-TP, is fitted with a membrane keyboard with keys and LEDs, and terminal blocks. The membrane keyboard can be deactivated by means of a proper parameter while configuring the device.

When switching the device in manual mode, by acting on the membrane keys it is possible to activate the device's outputs; this allows testing the connected valves and fan group. On the front side there is also a pushbutton for programming mode activation with relative LED and the terminals for connecting the KNX bus line.

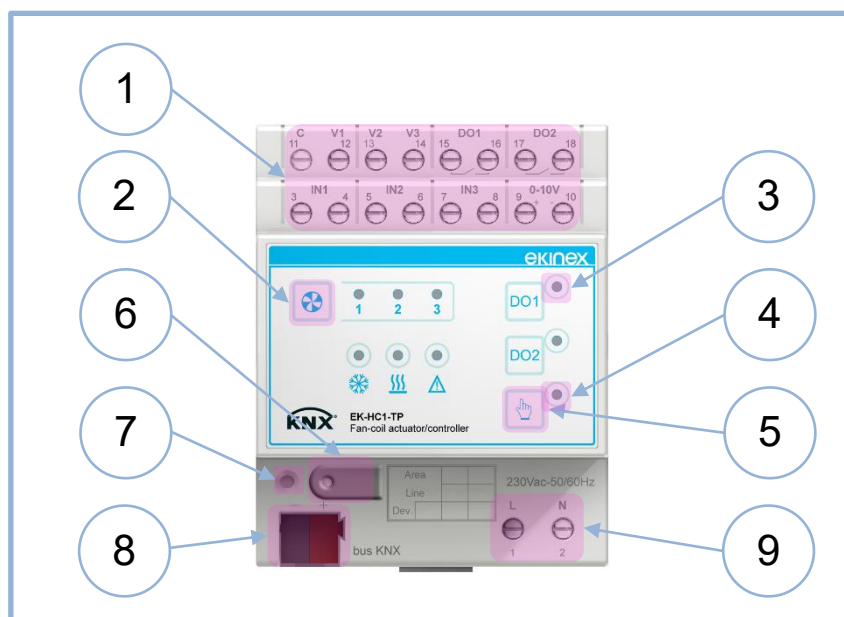

Figure 1 - Switching, display and connection elements version EK-HC1-TP

1. Output terminal blocks	6. Programming pushbutton
2. Membrane key to manually activate outputs	7. Programming LED
3. LED indicators for outputs' manual status	8. Terminal block for KNX bus line
4. LED indicator for manual mode active	9. Terminal block for 230 Vac auxiliary power supply
5. Membrane key for manual mode activation	

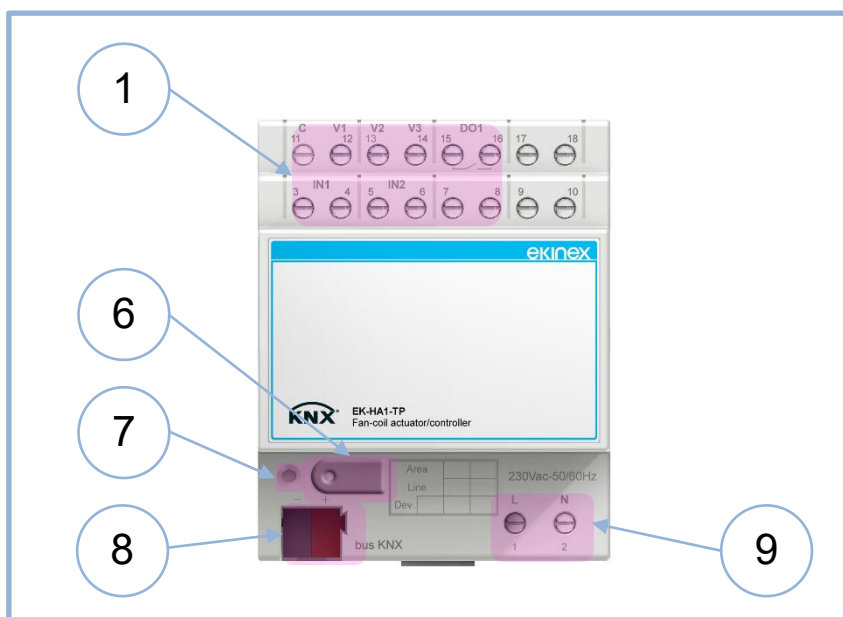

Figure 2 - Switching, display and connection elements version EK-HA1-TP

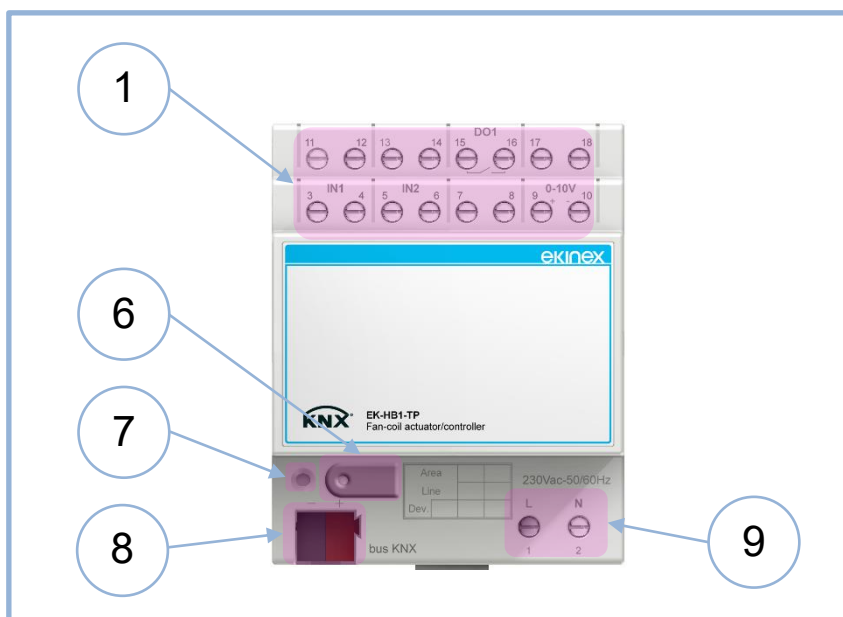

Figure 3 - Switching, display and connection elements version EK-HB1-TP

4 Configuration

The exact functionality of the device depends on the software settings.

In order to configure and commission the device you need ETS4 or later releases and the ekinex® application program, APEKHx1TP##.knxprod, which can be downloaded from the ekinex website www.ekinex.com.

The application program allows the configuration of all working parameters for the device.

The device-specific application program has to be loaded into ETS or, as alternative, the whole ekinex® product database can be loaded; at this point, all the instances of the selected device type can be added to the project.

For every single device, ETS allows to set the operating parameters separately for each function as described in detail in the following chapters.

Product code	EAN	No. of channels	ETS application software (## = release)	Communication objects (max no.)	Group addresses (max no.)
EK-HA1-TP		-	APEKHA1TP##.knxprod	45	254
EK-HB1-TP		-	APEKHB1TP##.knxprod	45	254
EK-HC1-TP		-	APEKHC1TP##.knxprod	123	254



Configuration and commissioning of KNX devices require specialized skills; to acquire these skills, you should attend training courses at a training centre certified by KNX.

For further information: www.knx.org.

5 Commissioning

After the device has been configured within the ETS project according to user requirements, the commissioning of the device requires the following activities:

- electrically connect the device, as described in the product datasheet, to the bus line on the final network or through a purposely setup network for programming;
- apply power to the bus;
- switch the device operation to programming mode by pressing the programming pushbutton located on the rear side of the housing. In this mode of operation, the programming LED is turned on steady;
- upload the configuration (including the physical address) to the device with the ETS program.

At the end of the upload, the operation of the device automatically returns to normal mode; in this mode the programming LED is turned off. Now the device is programmed and ready for use on the bus.

6 Function description

The device works as a controlled switch, detecting inputs' statuses and activating the outputs based on received command from bus as KNX frames, according to the temperature controller's logic.

The logic outputs are binary (or digital), i.e. can only assume two values, "On" and "Off"; each output is equipped with a unipolar relay with a contact sized to carry 5 A at 230 Vac.

6.1 Switching on

After connecting the bus line, the device becomes fully functional after a short time (tenths of ms) needed for reinitialization. A delay is programmable for the device to become active on the bus in order to avoid a bus traffic overload during the first moments of start-up of the whole network.

If the auxiliary power is already present (or when it will be), the device is ready.

6.2 Offline operation

The device will be partially functional in case one of the two power supplies (KNX bus line or auxiliary 230 Vac) should be missing. The internal circuit dedicated to logic and communication is powered by KNX bus line; output relays, for consumption reasons, are powered by auxiliary supply only.

Should both power supply be off, the device will be completely not functional.

6.2.1 Operation with bus power only

In case of no auxiliary power, all functions not related to outputs are active; however, relay switching will not be active.

In order to detect this normally undesired situation, it is possible to enable a communication object which activates an alarm, so that other devices on the bus can take all proper countermeasures and/or display the anomaly to the user.

In order to show a visual indication of lack of auxiliary power, all LEDs on the panel will blink.

6.2.2 Operation with auxiliary power only

When KNX bus is disconnected, or in case of bus voltage failure (voltage less than 19 V for more than 1 s), all device functions are stopped, particularly those related to timers.

When the power is restored, the device will resume operation in its previous state (which is saved on power fail), unless different initialization settings are programmed.

6.3 Manual operation

Manual operation constitutes an alternative to input switching through bus commands; this mode is meant for test or maintenance only.

6.3.1 Output status when mode changes

When manual mode is activated, outputs' statuses are not modified. When manual mode is active, the frames coming from the bus do not affect the physical outputs; the output contacts can be switched only if the corresponding membrane key on the front side is pressed.

The manual activation/deactivation of the outputs does not generate any feedback frame. The LED linked to the outputs, however, will continue to display their status nonetheless.

Even when manual mode is deactivated, the actual output status remains unaltered.

From another point of view, the situation could be explained by saying that during manual mode it is like the variables were temporarily "unconnected" from group addresses. When "reconnecting" them (exit from manual mode) their value remains unaltered until a new command from bus does not alter them.

The same considerations made for the command from bus are valid for state changes caused by internal timing functions (e.g. ctivation delays or stairs light function): those state changes have no effect while manual mode is active.

6.3.2 Manual mode activation

The actuator/controller EK-HC1-TP is fitted with a membrane keyboard to perform manual commands which are useful during commissioning phase.

In order to switch to manual mode you have to proceed as follows:

- 1) press the manual mode pushbutton on the front side of thee device. During normal operation, this LED is off; when this LED goes on, the membrane keys become active and manual mode is activated;

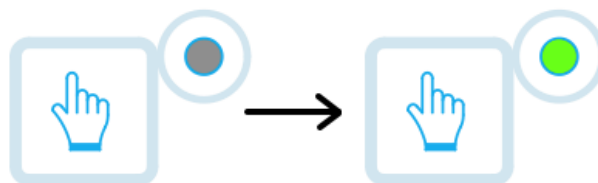

- 2) press the key corresponding to the channel you wish to activate (in the example: DO1). Pressing it several times perform a toggle between On and Off states.



- 3) when testing phase is over, deactivate manual mode by pressing again the manual mode pushbutton. Returning to normal mode, the indicator LED will display the output state again, which will be restored as described.



The switch to manual mode through frontal panel can be inhibited in two ways, both configurable:

- by completely disabling manual mode functionality;
- by a command from bus.

Please note that the command from bus prevent the device from changing mode through the proper pushbutton, but does not actually changes the mode.

If manual mode is not inhibited from configuration nor defined as bus controlled, through a different parameter it is possible to set a timeout after that, if the device has been left in manual mode, it is automatically brought back to normal operation. This prevents the device from being left in an uncontrollable state by mistake.

6.4 Online operation

All functions described below presume that the device has been correctly configured with ETS. An unprogrammed device does not perform any task on the bus; however, it can be activated through the membrane keyboard, making it switch to manual mode (only version EK-HC1-TP).

6.4.1 Software working cycle

The tasks performed by the software are the following:

- update the internal state variables based on KNX frames;
- implement the functions related to timing and other integrated functions to determine the state of the outputs;
- activate the output relays based on the logical outputs' status;
- answer to the requests related to the communication objects received via bus

In addition, there are particular events that can trigger additional features. These events are, for example, a bus power failure or restore, or an ETS new configuration load.

6.4.2 State variables (communication objects)

The device status, with particular attention to its interface elements (outputs) is based on *state variables* which are automatically defined by the application program. When a state variable is assigned to a group address, this variable automatically becomes a KNX communication object; therefore, it inherits all the usual characteristics of communication objects, such as the use of *flags* to determine the impact of the object modification on its bus transmission.

6.5 Applications

ETS configuration programs of actuators/controllers EK-Hx1-TP are suitable for the following applications:

- **Ventilation:** air flow is controlled through a 1-3 discrete speed control or through a continuous control with 0-10V signal; no water heat exchange coil is controlled.
- **Convectors:** heat exchange coils are controlled (2 or 4-pipe distribution systems); no control is performed on air flow. This configuration is suitable for controlling room terminal units whose air flow is controlled by an independent primary air treatment unit common for all environments.
- **Fan-coils:** both air flow and heat exchange coils' temperature are controlled.

The outputs which are not used for the application can be used for purposes other than temperature control and are controlled by means of proper communication objects exposed in the application program.

6.6 Operation as actuator

6.6.1 Choosing the control variable type

When operating as actuator, in order to make the integration with the temperature controller device easier, it is possible to use several Data Point Types for control communication objects. Fan speed control can be performed through the following type, which can be selected in the ETS application:

- [DPT 1.001] switch – Each speed is associated to a 1-bit communication object; the communication objects are mutually interlocked by the software. The speed associated to the communication object modified during the last receiving event prevails.
- [DPT 5.010] counter pulses – This 1-byte communication object can assume several values based on selected discrete speed (0=OFF, 1=Speed1, 2= Speed2 and 3= Speed3) or continuous speed (0=OFF, 1=20%, 2=40%, 3=60%, 4=80% 5=100%). Values of the communication object which are coherent with the performed configuration (1-3 or continuous speed) are not taken into considerations by the actuator.
- [DPT 5.001] percentage (0 ..100%) – This 1-byte communication object allows actuating both a 3-speed fan (the percentage speed thresholds are set in the application software) and a continuous fan with 0-10V control signal.

In convector applications, the heat exchange coils command is realized through 1-bit communication objects ([DPT 1.001] switch): the temperature controller can send both ON/OFF and PWM commands. Otherwise, in fan-coil applications the coil command can be single and separated from the fan command: in case of single command, the valves open when at least Speed1 is selected; in case of separated commands, the same considerations of convector applications apply.

Diagrams displaying the transfer functions between percentage command value and discrete set speed or continuous speed percentage (linearized on 0-10V control signal) are shown in *Fan* section, inside the chapter about ETS application program and use of the device as actuator.

6.6.2 Control variable timeout alarm

In order to guarantee the reliability of the frame exchange between controller and actuator on the bus, it is possible to add a time check when every command is received: when the preset time expires, if no new commands are received, the actuator's outputs can be forced in predefined positions.



When setting a timeout different from 0, make sure to set cyclic sending of commands on the device acting as temperature controller. In order to work correctly, the cyclic sending must assume values less than the preset timeout.

6.7 Operation as controller and actuator

The room air temperature control is performed thanks to the intercept valve(s) on the heat exchange coil(s), with an ON/OFF or PWM control algorithm. In order to control the intake air flow, different modes are available, according to the control needs and the kind of actuator used for the fan unit.



If the room controller heating/cooling function is set to either “cooling” or “both heating and cooling”, then the heating/cooling status immediately after the download is “cooling”. Otherwise, if the selected heating/cooling function is set to “heating”, then heating/cooling status immediately after download is “cooling” and after 2-3 seconds it switches to “heating”. This is the stored function, unless further changes occur.

6.7.1 Control algorithms

6.7.1.1 1-2-3 speed ON/OFF control

It is the most common algorithm used to control air flow in air terminal units and it is available in EK-HA1-TP and EK-HC1-TP versions, in combination with fan units equipped with an asynchronous motor with 3

independent windings. In case of motors with 5 windings, it is suggested to connect 3 windings to the minimum, medium and maximum speed according to the treated air flows. It is also possible to configure the algorithm with 1 or 2 speeds only.

This simple algorithm is also used in devices with a 0-10V control output (both EK-HB1-TP and EK-HC1-TP versions): in ETS application program, it is possible to set the output percentage linked to each air flow threshold.

The algorithm perform an ON/OFF control on 3 different air flow windows based on the error between the setpoint temperature and the actual measured room temperature. The threshold values, as well as the activation hysteresis, do not change from heating to cooling mode. However, the error has a different meaning in those 2 conduction modes:

- Heating: $error = (T_{setpoint} - T_{measured})$
- Cooling: $error = (T_{measured} - T_{setpoint})$

6.7.1.2 Proportional control with continuous output

This algorithm is available in EK-HB1-TP and EK-HC1-TP versions, in combination with fan units equipped with a brushless motor and 0-10V control signal. This algorithm performs a more accurate control of the room temperature; the power consumption of the actuator is also reduced, as well as the noise caused by the fan unit rotation. To avoid a temperature error while at steady condition, a minimum rotation speed is applied, as well as an hysteresis cycle for reboot after shutdown, when the setpoint temperature has been reached.

6.7.1.3 Proportional-integral control with continuous output

It is a variation of the previously explained algorithm, which is available in EK-HB1-TP and EK-HC1-TP versions, in combination with fan units equipped with a brushless motor and 0-10V control signal. Compared to the proportional control with continuous output, a contribution which is proportional to the integral of the temperature error is added; this allows an even more accurate control, especially when combined with PWM control of the valves on heat exchange coils. Please note that this solution makes the fan unit work continuously.



Diagrams displaying the transfer functions between temperature error and discrete set speed or continuous speed percentage (linearized on 0-10V control signal) are shown in *Fan* section, inside the chapter about ETS application program and use of the device as controller.

6.7.2 Setpoint management

The device is not equipped with a local interface to control the integrated room thermostat, therefore the temperature setpoint modifications need to be performed by another KNX device (supervisor) and sent to this device through communication objects.

Three setpoint management modes are foreseen:

- Single setpoint;
- Relative setpoints;
- Absolute setpoints.

Single setpoint mode

In this mode, a unique communication object is exposed (*Input Setpoint*) to modify the desired temperature. This object can be updated cyclically or on event of change by the supervisory device. If power goes down, the last value is retained into the pushbutton's non-volatile memory. In case the object is not updated, the temperature controller acts anyway on default setpoints (both heating and cooling) set in the application program during commissioning.



If a temperature controller is set on both heating and cooling mode, it is necessary that the supervisory device also updates the input seasonal mode object (*Heating/cooling status in*, [1.100] DPT_Heat_Cool) in order to coherently switch over the controller's action.

If window contacts for energy saving are used, when detecting an open window the input setpoint freezes and the pre-set building protection setpoint is activated (the relative communication object is exposed and is different in heating or cooling mode).

Relative setpoints mode

In this mode, 4 communication objects are exposed, one for each operating mode:

- Comfort setpoint
- Stand-by offset
- Economy offset
- Building protection setpoint

Stand-by and economy setpoints are represented as attenuations to the comfort setpoint in order to facilitate the supervisor management: by uniquely modifying the comfort setpoint, references for attenuated modes are automatically transferred. The values modified from bus are retained in the pushbutton's non-volatile memory.

With this mode, the supervisory device can develop an hour-based time scheduling by sending to the device the current operating mode (comm. obj. *HVAC mode in* [20.102] DPT_HVAC Mode). The default value for *HVAC mode in* corresponds to the comfort setpoint value.

Same as single setpoint management, if the temperature controller is set as both heating and cooling mode with switch over from bus, it is necessary that the supervisory device also updates the input seasonal mode object (*Heating/cooling status in*, [1.100] DPT_Heat_Cool) in order to coherently switch over the controller's action.

Absolute Setpoint mode

In this mode, 3 communication objects are exposed, for each conduction mode:

- Comfort setpoint;
- Standby setpoint;
- Economy setpoint;
- Building protection setpoint.

All setpoint are absolute values: by modifying those values from bus through communication objects you need to keep the coherence among the values of the attenuated operating modes.

With this mode, the supervisory device can develop an hour-based time scheduling by sending to the device the current operating mode (comm. obj. *HVAC mode in* [20.102] DPT_HVAC Mode). The default value for *HVAC mode in* corresponds to the comfort setpoint value.

Same as single setpoint management, if the temperature controller is set as both heating and cooling mode with switch over from bus, it is necessary that the supervisory device also updates the input seasonal mode object (*Heating/cooling status in*, [1.100] DPT_Heat_Cool) in order to coherently switch over the controller's action.

6.7.3 Operating modes

In Single Setpoint mode, 2 levels for each conduction mode are available:

- Temperature setpoint
- Building protection setpoint

Time scheduling for attenuation can be realized by the supervisor, by directly modifying the temperature setpoint.

In Relative and Absolute Setpoint mode, 4 different operating modes are available, which are mutually exclusive to one another:

- comfort;
- stand-by;
- economy;
- building protection.

Through ETS application program, it is possible to assign 2 different setpoint values to each operating mode, for comfort and building protection level, and two different attenuation levels for stand-by and economy, corresponding to both heating and cooling.

Each setpoint is exposed through communication objects. Setpoints and attenuations can be modified remotely through the exposed communication objects. The setpoint intervention for building protection must be planned in ETS application program, as these parameters concern the safety and protection of the plant's components (especially during heating).

6.7.4 Heating/cooling switch over

The switch over between both heating and cooling mode can take place in 3 ways:

1. from KNX bus, through a communication object;
2. automatically, based on the room temperature;
3. automatically, based on the heat exchange coil temperature

Switchover from bus

In mode 1, the switch over command is issued through KNX bus and therefore it is performed by a different KNX device, e.g. the ekinex® Touch&See unit. The integrated temperature controller acts as a “slave”: the switch over is carried out by input communication object [DPT 1.100 heat/cool].

Automatical switch over, based on the room temperature

Mode 2 is suitable for applications with heating / cooling systems with a 4-pipe configuration and is available in EK-HC1-TP version only. In addition, the information can be transmitted on the bus through an output communication object [DPT 1.100 heat/cool]; the difference with mode 1 is that the switch over is performed automatically by the machine, basing on the values of current temperature and setpoint. The automatic switch over is achieved by introducing a dead band as shown in the following figure.

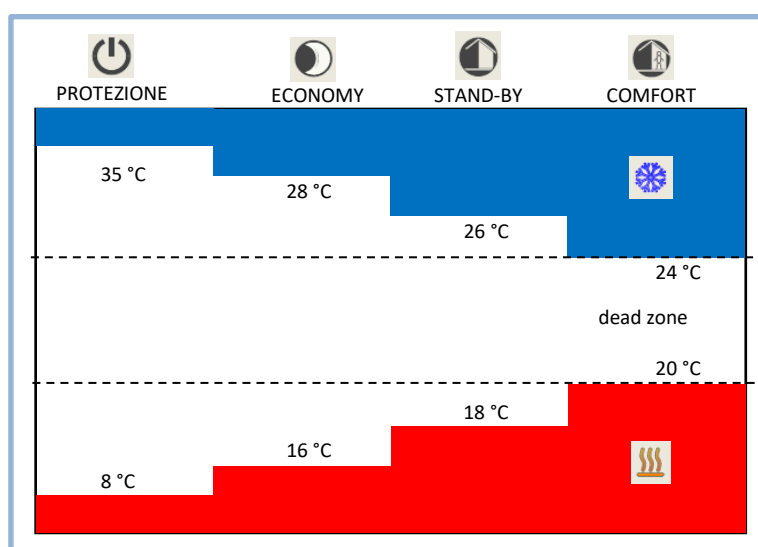

The figure shows that, as long as the actual measured temperature is below the heating mode setpoint, the heating mode is selected; similarly, if the value is greater than the cooling setpoint, then cooling mode is selected. If the value is within the dead band, the operation mode remains unchanged until the value itself passes over the threshold value associated with the opposite mode.

Automatical switch over, based on the heat exchange coil temperature

In case of heating / cooling systems with a 2-pipe configuration, it is possible to set an automatic conduction mode switch over (from heating to cooling and vice versa) by measuring the heat exchange fluid temperature with a proper temperature sensor, which has to be installed on the intake pipe of the heat exchange coil and needs to be connected to an analog input on the device (or to another KNX device equipped with an analog input).

In order to achieve that, 2 temperature thresholds are defined: if the heat exchange temperature is less than a *low threshold* (e.g. 18°C), the device switches to cooling mode; if it is greater than a *high threshold* (e.g. 28°C), the device switches to heating mode

6.7.5 Temperature control alarm

The integrated temperature controller can stop the internal control algorithm for one of the following reasons:

- For an external event, which can be configured and linked to the *Thermal generator lock* communication object;
- For an internal temperature sensor's fault (measured room temperature too low while NTC resistance value is too high or vice versa);
- For a timeout (data not updated by the bus) when a weighted mean between the internal sensor's value and an auxiliary external sensor's value is used.

When one of these events occur, the internal controller stops the control algorithm and the command output is taken to complete closing position (OFF or 0%): this state is signalled through the communication object *Temperature control alarm*.

6.8 External inputs and inputs from bus

The EK-Hx1-TP actuators/controllers are equipped with 2 inputs (EK-HC1-TP version only: 3 inputs) freely programmable as analog or binary. Moreover, when using the device as integrated temperature controller, variables acquired by bus through communication objects are also available. All external and bus inputs allow extending the device functionality.

6.8.1 Room temperature or return air temperature for control

In case no external controller is used (for example a KNX room thermostat), the device can alternatively use:

- 1) the temperature value of the air mass measured by a sensor connected to an analog input, installed on an internal wall at approx. 1,50 m.
- 2) the temperature value measured by a sensor connected to an analog input and positioned next to the return air grid.

6.8.2 External climate compensation

When the integrated controller is in cooling mode, if an external temperature sensor is connected to an analog input or if a value from bus is acquired from bus through a communication object, it is possible to perform a climate compensation on the desired room temperature.

This compensation allows automatically raising the desired temperature as the external summer climate becomes too warm, thus avoiding discomfort when passing from outside to inside. The curve is set first by selecting an initial external temperature value and then selecting the growth gradient of the desired temperature.

6.8.3 Heat exchange coil temperature for hot and cold start

In both heating and cooling modes, in order to avoid the possible discomfort caused by an air flow whose temperature is too different from the actual one, the device does not start the fan unit until the heat exchange fluid inside the heat exchange coil has not reached a suitable temperature value. This situation normally happens at first start or after long inactivity periods. This function can be performed through:

- 1) a temperature control through temperature sensor (minimum/maximum sensor) installed on the heat exchange coil of the fan-coil unit;
- 2) a delayed start through a proper time interval setting (approximation function).

Minimum/maximum sensor. In the first case, the temperature of the heat exchange fluid flowing inside the coil is measured: the function performs an actual temperature control. For the operation it is necessary that the minimum/maximum sensor is connected to an analog input. Alternatively, the temperature value can be received via bus from a different KNX device equipped with analog inputs, where the sensor is connected.

6.8.4 (2-sensor) antistratification temperature

Fan-coil units are realized in different construction shapes for floor, wall or ceiling installations. In particular cases, such as rooms with height and volume much higher than usual (atriums, fitness facilities, commercial buildings, etc.) during heating season warm air can accumulate in the highest part of the room; the air stratification phenomenon can cause energy waste and discomfort.

In order to find a remedy for this situation, the device is equipped with a 2-sensor antistratification function, which forces the fan unit in first speed. This function requires measuring of the temperature at two heights through the installation of a second temperature sensor at an adequate height in order to measure the actual air stratification (the main room temperature controller is supposed to be installed at 1.5 m).

For rooms with ordinary height (2,70÷3,00 m) the DIN 1946 standard recommends not to exceed 2 K/m in order to have an adequate comfort; this gradient may be bigger in higher rooms.

6.8.5 Water intake temperature for automatic heating/cooling switch over

The heat exchange fluid temperature measurement can be done by means of a proper temperature sensor to be installed next to the intake pipe of the heat exchange coil, connected to an analog input of the device (or to a different KNX device equipped with analog inputs).

6.8.6 Generic temperature acquisition

The analog input can be used to acquire a generic temperature value by means of a traditional NTC (10 kΩ at 25°C) sensor. The measured value can be sent on the bus and used by other KNX devices, for example for display purposes or calculation of a weighted mean average by a room thermostat.

6.8.7 Window contacts

In order to realise energy-saving functions, window contacts (to detect the opening of windows or doors) can be used. The device can acquire the status of a contact by means of a digital input or receive the status of two contacts connected to different KNX devices (binary inputs, pushbutton interfaces). When a window opens, the device automatically switches to *Building Protection* operating mode; when it closes, the device automatically returns to the previous operating mode. When acquiring two signals, they can be combined in logical OR.

The window contact management is an optional feature, oriented to energy saving, which is available only when the actuator/controller fan-coil is configured as integrated temperature controller. When an open window is detected, the operating mode is forced into building protection and remains forced until all windows are closed. The application program features a time parameter for opening delay to discriminate between an occasional, short opening and a long opening, which justifies the energy saving mode recall.

The window contact management has absolute priority over the operating mode forced by time scheduling, over the mode forced by presence sensors (if enabled) and over the HVAC mode forced by supervisor through the communication object *HVAC Forced mode in DPT 20.102*.

6.8.8 Presence sensors

Presence sensors management includes a set of optional features, oriented to energy saving, which become available when the device is configured as integrated controller.

Generally speaking, if a human presence is detected and limited to the occupancy period, the comfort operating mode can be extended; vice versa, if no presence is detected, the comfort operating mode can be limited, because no longer necessary.

The occupancy status detection is performed by presence sensors which can be connected to KNX devices equipped with binary inputs; the actuator/controller for fan-coil units exposes up to 2 1-bit communication objects which can be synchronized to the situations detected by the sensors. An internal logic performs a

logical OR or the states of the connected sensors: in order to activate the energy saving function, at least one sensor needs to detect a presence. In order to determine which physical state corresponds to the presence state, two different options can be selected:

- Not inverted (normally closed): an open contact corresponds to non-occupancy state, a close contact corresponds to detected presence;
- Inverted (normally open): an open contact corresponds to detected presence, a close contact corresponds to non-occupancy state;

There are three presence state management modes: comfort extension, comfort limitation and a combination of these two modes.

Comfort extension. This function is only active if the actual operating mode is set on comfort; if, during this time, a presence is detected, the operating mode remains comfort even if the operating mode forced by the time scheduling function shifts to economy or standby. If a presence is not detected for a time period less than a preset time, the operating mode does not change; vice versa, if a presence is not detected for a time period greater than the same preset time, the operating mode becomes the one forced by the time scheduling function.

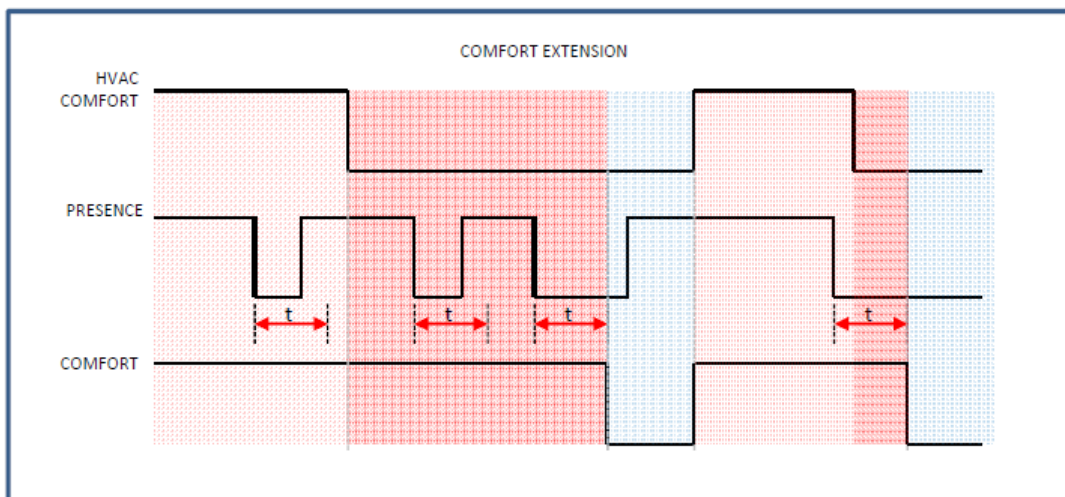

The figure above shows that, even if a presence is detected while the operating mode forced by the time scheduling function is not comfort, no change of operating mode is performed until the next programmed comfort event.

In case a forced HVAC mode is used by a supervisor through the communication object *HVAC forced mode* in DPT 20.102, the forced operating mode has a higher priority compared to the mode foreseen by the presence management, so it will prevail.

In case the energy saving management is carried out through window contacts, the latter has a higher priority compared to both the forced mode and the mode foreseen by the presence management; whatever operating mode is forced by the time scheduling function, by presence management or by forced mode, the system switches to building protection mode when detecting an open window.

Comfort limitation. This function is only active if the actual operating mode is set on comfort; if, during this time, a presence is not detected for a time period greater than a preset time, the operating mode shifts to economy or standby. The attenuation modes can be selected in the application program and are independent from the modes foreseen by the time scheduling function.

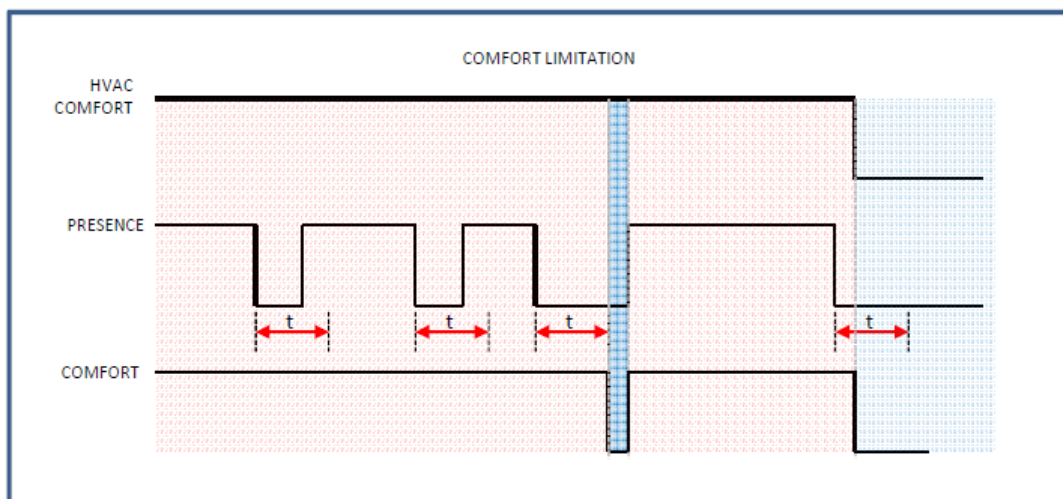

Same as comfort extension, in case a forced HVAC mode is used by a supervisor through the communication object *HVAC forced mode in DPT 20.102*, the forced operating mode has a higher priority compared to the mode foreseen by the presence management, so it will prevail.

In case the energy saving management is carried out through window contacts, the latter has a higher priority compared to both the forced mode and the mode foreseen by the presence management; whatever operating mode is forced by the time scheduling function, by presence management or by forced mode, the system switches to building protection mode when detecting an open window.

Comfort extension and comfort limitation. This mode is a combination of comfort extension and comfort limitation modes.

6.9 Drip tray control

When in cooling mode, drip water collected inside the proper basin can be discharged by means of a discharge pump. When the level inside the basin reaches the safety threshold, a proper communication object changes its state; this communication object can be used as standalone or in logical OR with other objects of the same type, in order to activate a binary output that activates the drip tray discharge pump.

6.10 Filter monitoring

Fan-coil units are equipped with a filter that absorbs and hold the suspended dust before air is sent into the environment. The filter is extractable for cleaning and substitution operations. In order to execute the monitoring function, the device is equipped with a working hour counter; the fan group needs to be set at least to 1st speed in order for the counter to work. When the time interval set in the proper parameter has been reached, a communication object warning about the filter substitution is issued. The same object can be used to suppress the warning and simultaneously reset the counter.

6.11 Valve protection

The thermal plant where the fan-coil units are installed uses water as heat exchange fluid and units are equipped with motorized valves to intercept the hydraulic circuits. Under particular conditions, long inactivity periods can block those valves: to prevent this problem, the device can periodically activate an open/close cycle for the valves.

To perform such function, the device is equipped with a separated counter for each valve, which is activated every time the actuator completely closes the valve. When that counter reaches the value set in parameter *Frequency*, the valve is opened to prevent it from getting stuck. The duration of this opening depends on the value set in parameter *Time interval*. If the actuator brings the valve to fully open position before the time interval is reached, the counter is reset and then rebooted when the valve is closed again. The valve protection function is available when the device is configured both as actuator and as controller.

6.12 Auxiliary output

This function is available in EK-HC1-TP version with 2 outputs to command heat exchange coils when the system is configured as 4-pipe. In case the system is in 2-pipe configuration, the output dedicated to the cooling coil interception can be used as an auxiliary output. Some fan-coil units can be equipped with an auxiliary heating coil based on an electric resistance. The most common use of this solution is when a hot heat exchange fluid coming from the thermal station is not available, for example when the weather outside is already cold but the plant has not been activated yet. This auxiliary coil is to be considered as an alternative to the heat exchange coil and not as an additional element to raise the heating power supplied by the water coil.

The auxiliary output is available in convector and fan-coil in 2-pipe configuration applications, both with internal and external controller.

The auxiliary output can be handled in the following ways:

- Command from bus
- Active with heating request
- Together with heating valve

In Command from bus mode, the binary output is controlled by a 1-bit communication object with an external logic. In the second mode, the auxiliary output is by all means a second ON/OFF stage. In the last mode, the auxiliary output follows the behaviour of the heating valve: for example, if the valve command is set on PWM (pulse width modulation), the auxiliary output repeats the pulses of the heating valve, as a parallel output.



Make sure that the auxiliary coil is equipped with a safety thermostat which can intervene in case of a coil's internal overtemperature.

7 Application program for ETS

In the following chapters, there is the list of folder, parameters and communication objects of the application program.

i

The parameter values highlighted in bold represent the default value.

The device settings are divided in two main groups: the *general* settings and the *channel-specific* settings. The settings are grouped in folders. The following figure shows the tree structure of the application program, with the main folders:

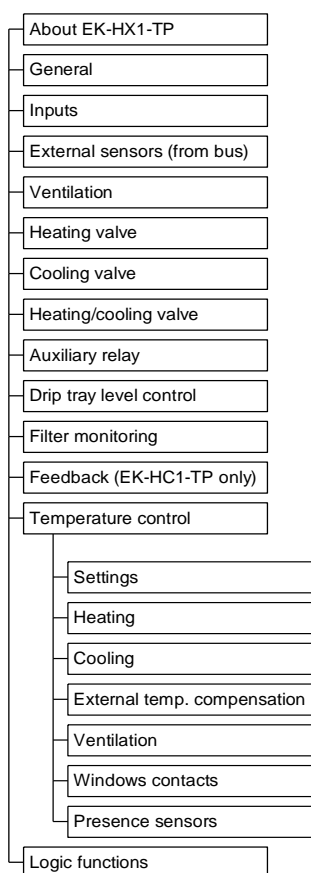

7.1 About EK-HX1-TP

The folder **About EK-HX1-TP** is for information purposes only and does not contain parameters to be set. The information given is for instance:

© Copyright Ekinex S.p.A. 2019-2024
 Application software for ETS4 (or later)
 Version 2.00 (or later)
 Fan-coil actuator KNX EK-Hx1-TP
 Ekinex S.p.A.
 Via Novara, 37
 I-28010 Vaprio d'Agogna (NO) Italy
www.ekinex.com
info@ekinex.com

7.2 General

This folder contains the general settings for the device configuration:

- Application type: ventilation, convector or fan-coil
- Function: heating, cooling and both heating and cooling
- Installation type (for version EK-HC1-TP): 2-pipe or 4-pipe
- Device use: as actuator with external controller or as actuator/controller with internal controller.

Parameter name	Conditions	Values
Application		ventilation convector fan-coil
Function		heating cooling both heating and cooling
Installation Type (*)	Function = both heating and cooling, Application = convector, fan-coil	2 pipes 4 pipes
	(*) Parameter only available for EK-HC1-TP version	
Controller		external internal
Communication object	Controller = external, Application = fan-coil	unique separated
Ventilation object format	Controller = external, Application = ventilation, Application = fan-coil	output status [DPT 1.001] counter [DPT 5.010] percentage [DPT 5.001]
Valve object format	Controller = external, Application = convector, Application = fan-coil and Communication object = separated	output status [DPT 1.001]
	<i>In the current version of the devices, only this option is available.</i>	
Communication object timeout	Controller = external	00:05:00 hh:mm:ss [range 00:00:00 ... 18:12:15]
	<i>This parameter allows disabling the actuator outputs and generating a communication alarm if the object or command objects are not updated within the timeout set. The field has the format hh:mm:ss (hours:minutes:seconds). The default 0:05:00 therefore corresponds to a 5 minute timeout. The 00:00:00 means that the update control for command objects is disabled.</i>	
Manual operation (*)		disabled enabled
	(*) Parameter only available for EK-HC1-TP version	
Disable from bus (*)	Manual operation = enabled	no/yes
	(*) Parameter only available for EK-HC1-TP version	

Parameter name	Conditions	Values
Restore auto mode time (*)	Manual operation = enabled	00:15:00 hh:mm:ss [range 00:00:00 ... 18:12:15]
	(*) Parameter only available for EK-HC1-TP version	
Power status feedback		disabled enabled
Report filter change		no /yes
Delay after bus voltage recovery		00:00:05 hh:mm:ss [range 00:00:00 ... 18:12:15]
	<p>Time interval after which the transmission of the telegrams on the bus starts after the power supply is restored. The delay affects both the event-driven transmission and the cyclic transmission of a telegram. Regarding the latter, the counting of the pause interval for retransmission starts at the end of the time of initial delay.</p> <p>The field has format hh:mm:ss:fff (hours : minutes : seconds .milliseconds): the default value 00:00:05.000 corresponds to 5 seconds.</p>	
Logic Functions (*)		disabled enabled
	(*) Parameter only available for EK-HC1-TP version	

Object name	Conditions	Dim.	Flags	DPT	Comm. Obj. No.
Test mode activated (*)	Manual operation = enabled	1 Bit	CR-T--	[1.003] enable	6
	(*) Parameter only available for EK-HC1-TP version				
Disable front keyboard (*)	Manual operation = enabled, Disabled from bus = yes	1 Bit	C-W---	[1.002] boolean	74
	(*) Parameter only available for EK-HC1-TP version				
Technical alarm		1 Bit	CR-T--	[1.005] alarm	15
	<i>The alarm is activated in case of terminal inputs probes fault (for analog sensors, contact open or short-circuit).</i>				
Communication alarm		1 Bit	CR-T--	[1.005] alarm	16
	<i>The alarm is activated in case of timeout of sensors from bus; in the case of controller = external alarm is activated if the control communication objects are not updated within the configured time-out with the parameter Communication object timeout.</i>				
Thermal generator locked		1 Bit	C-W---	[1.005] alarm	18
	<i>This C.O. is used from an external device to stop operation both as actuator and as regulator. If the controller = external, when the alarm is received the outputs and ventilation stop. If controller = internal, also the internal temperature controller is stopped.</i>				
Temperature control alarm	Controller = internal	1 Bit	CR-T--	[1.005] alarm	19
	<p><i>The internal temperature controller alarm is active in one of the following conditions:</i></p> <ul style="list-style-type: none"> • Failure of one of the temperature sensors used for control • Timeout reception of a temperature sensor used for control • Alarm reception from C.O. Thermal generator locked • Receiving a full condensate pan state (if configured ≠ only reporting). 				
Filter change warning	Report filter change = yes	1 Bit	CR-T--	[1.005] alarm	64
Power off alarm	Power status feedback = enabled	1 Bit	CR-T--	[1.005] alarm	75

Object name	Conditions	Dim.	Flags	DPT	Comm. Obj. No.
Alarm text		14 Bytes	CR-T--	[16.000] Character String (ASCII)	83
<p style="text-align: center;"> <i>This Data Point Type is used to transmit the alarm signal as a sequence of ASCII characters. The maximum string length is fixed at 14 characters (14 octets). Content is transferred starting from the most significant character (14 MSB). If the string to be transmitted is shorter than 14 characters, the unused bytes are filled with the NULL character (00h). Example: "EKINEX is OK" is represented as follows:</i> </p> <p style="text-align: center;">45h 4Bh 49h 4Eh 45h 58h 20h 69h 73h 20h 4Fh 4Bh 00h 00h</p>					
Output V1 from bus	Application = any, Ventilation ⇒ Control type = 3 speeds (0...10V) (*) o Ventilation ⇒ Control type = continuous regulation (0...10V) (*)	1 Bit	C-W---	[1.001] switch	76
<i>The output is not used for the ventilation command; the C.O. allows to control the relay output and dedicate it to other use (eg. command dedicated to lighting or the ON/OFF drive).</i>					
Output V2 from bus	Application = any, Ventilation ⇒ Control type = 1 speed (relay) or Ventilation ⇒ Control type = 3 speeds (0...10V) (*) o Ventilation ⇒ Control type = continuous regulation (0...10V) (*)	1 Bit	C-W---	[1.001] switch	77
<i>The output is not used for the ventilation command; the C.O. allows to control the relay output and dedicate it to other use (eg. command dedicated to lighting or the ON/OFF drive).</i>					
Output V3 from bus	Application = any, Ventilation ⇒ Control type = 1 or 2 speeds (relays) o Ventilation ⇒ Control type = 3 speeds (0...10V) (*) o Ventilation ⇒ Control type = continuous regulation (0...10V) (*)	1 Bit	C-W---	[1.001] switch	78
<i>The output is not used for the ventilation command; the C.O. allows to control the relay output and dedicate it to other use (eg. command dedicated to lighting or the ON/OFF drive).</i>					
Output DO1 from bus	Application = ventilation	1 Bit	C-W---	[1.001] switch	79
<i>The output is not used for the ventilation command; the C.O. allows to control the relay output and dedicate it to other use (eg. command dedicated to lighting or the ON/OFF drive).</i>					
Output DO2 from bus (**)	Application = ventilation, Controller = external	1 Bit	C-W---	[1.001] switch	80
<i>The output is not used for the ventilation command; the C.O. allows to control the relay output and dedicate it to other use (eg. command dedicated to lighting or the ON/OFF drive).</i>					
Output 0-10V from bus (*)	Application = any Ventilation ⇒ Control type = 1, 2 or 3 speeds (relays)	1 Byte	C-W---	[5.001] percentage (0...100%)	81
<i>The output is not used for the ventilation command; the C.O. allows to control the 0-10V output and dedicate it to other use.</i>					

(*) Options, parameters and C.O.s are available only for EK-HB1-TP and EK-HC1-TP versions.

(**) Options, parameters and C.O.s are available only for EK-HC1-TP version.

7.3 Inputs

EK-HA1-TP ed EK-HB1-TP versions are equipped with 2 inputs freely configurable as digital or analog; EK-HC1-TP version is equipped with 3 feely configurable inputs. This folder is enabled both when configured as actuator (*General* ⇒ *Controller* = external) and as actuator/controller (*General* ⇒ *Controller* = internal).

Parameter name	Conditions	Values
Input X		disabled [DI] generic contact [DI] window contact sensor [DI] drip tray level [AI] room temperature sensor [AI] outdoor temperature sensor [AI] coil battery temperature sensor [AI] antistratification temperature sensor [AI] flow temperature sensor [AI] generic (NTC) temperature sensor
<i>The [DI] prefix indicates a digital input, the prefix [AI] an analog input.</i>		
Contact type	Input X = [DI] ...	NO (normally open) NC (normally closed)
<i>Parameter always available when the input is configured as digital.</i>		
Debounce time	Input X = [DI] ...	00:00:00.200 hh:mm:ss.fff [range from 00:00:00.000 to 00:10:55.350]
<i>Parameter always available when the input is configured as digital. The field has the format hh:mm:ss.fff (hours: minutes: seconds. milliseconds): the default value of 00:00:00.200 therefore corresponds to 200 milliseconds.</i>		
Filter type	Input X = [AI] ...	low medium high
<i>Parameter always available when the input is configured as analog. Selectable values: Low = average value every 4 measurements Medium = average value every 16 measurements High = average value every 64 measurements</i>		
Offset	Input X = [AI] ...	0°C [range -5,0°C ... +5,0°C]
<i>Parameter always available when the input is configured as analog. If set to 0, no value is sent to the change.</i>		
Minimum change of value to send [K]	Input X = [AI] ...	0,5 [range from 0 to 5]
<i>Parameter always available when the input is configured as analog. If set to 0, no value is sent to the change.</i>		
Cyclic sending interval	Input X = different from disabled	no sending [other values in the range 30 s ... 120 min]
Threshold 1	Input X = [AI] ...	not active / below / above
Value [°C]	Input X = [AI] ... Threshold 1 = below or above	7 [from 0 to 50]
Threshold 2	Input X = [AI] ...	not active / below / above
Value [°C]	Input X = [AI] ... Threshold 2 = below or above	45 [from 0 to 50]

Parameter name	Conditions	Values
Hysteresis	Input X = [AI] ... Threshold 1 = below or above Threshold 2 = below or above	0,4 K [other values in the range 0,2 K ... 3 K]
Cyclic sending interval	Input X = [AI] ... Threshold 1 = below or above Threshold 2 = below or above	no sending [other values in the range 30 s ... 120 min]

Object name	Conditions	Dim.	Flags	DPT	Comm. Obj. No.
Room temperature sensor (from input X)	Input X = [AI] room temperature sensor	2 Byte	CR-T--	[9.001] temperature (°C)	20, 23, 26 (*)
	(*) C.O. available only for EK-HC1-TP version.				
Outdoor temperature sensor (from input X)	Input X = [AI] outdoor temperature sensor	2 Byte	CR-T--	[9.001] temperature (°C)	20, 23, 26 (*)
	Note: if both inputs are configured in the same way, only the first is used by the device function. (*) C.O. available only for EK-HC1-TP version.				
Coil battery temperature sensor (from input X)	Input X = [AI] coil battery temperature sensor	2 Byte	CR-T--	[9.001] temperature (°C)	20, 23, 26 (*)
	(*) C.O. available only for EK-HC1-TP version.				
Antistratification temperature sensor (from input X)	Input X = [AI] antistratification temperature sensor	2 Byte	CR-T--	[9.001] temperature (°C)	20, 23, 26 (*)
	(*) C.O. available only for EK-HC1-TP version.				
Flow temperature sensor (from input X)	Input X = [AI] flow temperature sensor	2 Byte	CR-T--	[9.001] temperature (°C)	20, 23, 26 (*)
	(*) C.O. available only for EK-HC1-TP version.				
Temperature value sensor (from input X)	Input X = [AI] generic (NTC) temperature sensor	2 Byte	CR-T--	[9.001] temperature (°C)	20, 23, 26 (*)
	(*) C.O. available only for EK-HC1-TP version.				
Temperature threshold 1 sensor (from input X) - Switch	Input X = [AI]...	1 Bit	CR-T--	[1.001] switch	21, 24, 27 (*)
	(*) C.O. available only for EK-HC1-TP version.				
Temperature threshold 2 sensor (from input X) - Switch	Input X = [AI]...	1 Bit	CR-T--	[1.001] switch	22, 25, 28 (*)
	(*) C.O. available only for EK-HC1-TP version.				
Generic contact (from input X)	Input X = [DI] generic contact			[1.001] switch	29, 30, 31 (*)
	(*) C.O. available only for EK-HC1-TP version.				
Window contact (from input X)	Input X = [DI] window contact sensor	1 Bit	CR-T--	[1.019] window/door	29, 30, 31 (*)
	(*) C.O. available only for EK-HC1-TP version.				
Drip tray contact (from input X)	Input X = [DI] drip tray level	1 Bit	CR-T--	[1.005] alarm	29, 30, 31 (*)
	(*) C.O. available only for EK-HC1-TP version.				

7.4 External sensors (from bus)

The possibility to connect external KNX sensors via KNX bus extends the device capabilities. This folder is only active when the device is configured as actuator/controller (*General* ⇒ *Controller* = internal).

Parameter name	Conditions	Values
Room temperature		disabled enabled
Outdoor temperature		disabled enabled
Coil temperature		disabled enabled
Antistratification temperature		disabled enabled
Flow temperature		disabled enabled
Analog sensors timeout		00:05:00 hh:mm:ss [range 00:00:00 ... 18:12:15]
	<i>The field has the format hh:mm:ss (hours:minutes:seconds): the default value 00:05:00 therefore corresponds to a 5 minute timeout. The 00:00:00 means that the time-out of analog sensors is deactivated.</i>	
Drip tray level		disabled enabled
Signal	Drip tray level = enabled	not inverted inverted
Window contact 1		disabled enabled
Signal	Window contact 1 = enabled	not inverted inverted
Window contact 2		disabled enabled
Signal	Window contact 2 = enabled	not inverted inverted
Presence sensor 1		disabled enabled
Signal	Presence sensor 1 = enabled	not inverted inverted
Presence sensor 2		disabled enabled

Parameter name	Conditions	Values
Signal	Presence sensor 2 = enabled	not inverted inverted
Digital sensors timeout		00:05:00 hh:mm:ss [range 00:00:00 ... 18:12:15]
<i>The field has the format hh:mm:ss (hours:minutes:seconds): the default value 00:05:00 therefore corresponds to a 5 minute timeout. The 00:00:00 means that the time-out of digital sensors is deactivated.</i>		

Object name	Conditions	Dim.	Flags	DPT	Comm. Obj. No.
Room temperature (from bus)	enabled	2 Bytes	C-W---	[9.001] temperature (°C)	32
Outdoor temperature (from bus)	enabled	2 Bytes	C-W---	[9.001] temperature (°C)	33
Coil battery temperature (from bus)	enabled	2 Bytes	C-W---	[9.001] temperature (°C)	34
Antistratification temperature (from bus)	enabled	2 Bytes	C-W---	[9.001] temperature (°C)	35
Water supply temperature (from bus)	enabled	2 Bytes	C-W---	[9.001] temperature (°C)	36
Drip tray contact (from bus)	enabled	1 Bit	C-W---	[1.005] alarm	37
Window contact 1 (from bus)	enabled	1 Bit	C-W---	[1.019] window/door	38
Window contact 2 (from bus)	enabled	1 Bit	C-W---	[1.019] window/door	39
Presence sensor 1 (from bus)	enabled	1 Bit	C-W---	[1.018] occupancy	40
Presence sensor 2 (from bus)	enabled	1 Bit	C-W---	[1.018] occupancy	41

7.5 Ventilation

The ventilation folder contains:

- the setting parameters for relays or continuous command outputs (for EK-HB1-TP and EK-HC1-TP versions) and the parameters for the output behaviour based on the values of the commands received from bus;
- the default values for the outputs when the timeout after receiving a command is reached;
- the fan activation and deactivation delays;
- the speed limitation activation (e.g. at night);

The ventilation folder is active if: *Application* = ventilation or fan-coil and *Controller* = external.

If *Controller* = internal, the folder is not enabled and an equivalent folder is activated inside the *Temperature control* folder.

Parameter name	Conditions	Values
Control type	General ⇒ Communication object = output status or counter or General ⇒ Ventilation object format = output status or counter	1 speed (relay) 2 speeds (relays) 3 speeds (relays) 3 speeds (0...10V) (*)
	<i>The continuous control option is not active in this condition because the command signal has only discrete values. (*) The option is only available for EK-HB1-TP and EK-HC1-TP versions.</i>	
Control type	General ⇒ Communication object = percentage or General ⇒ Ventilation object format = percentage	1 speed (relay) 2 speeds (relays) 3 speeds (relays) 3 speeds (0...10V) (*) continuous regulation (0... 10V) (*)
	<i>(*) The option is only available for EK-HB1-TP and EK-HC1-TP versions.</i>	
[...]		
	<i>Setting parameters depending on the adopted configuration. Please see the different situation in the following sections.</i>	
Speed at timeout	General ⇒ Communication object = output status or counter or General ⇒ Ventilation object format = output status or counter	stopped speed 1 speed 2 speed 3
	<i>If Control type = n speeds, this parameter has n+1 options. It is not possible to set a timeout for an unavailable speed.</i>	
Speed at timeout	General ⇒ Communication object = percentage or General ⇒ Ventilation object format = percentage	stopped from 10% to 100%
Disable from bus		no/yes
Signal	Disable from bus = yes	not inverted inverted
Fan speed limit from bus	Control type > 1 speed (relay)	not limited speed 1 speed 2
Start delay		0 s [other values in the range 10 s ... 12 min]
	<i>Also displayed if warm start function mode through water temperature measurement on heat exchange coil is used. This function is active in both heating and cooling modes.</i>	
Stop delay		0 s [other values in the range 10 s ... 12 min]

Parameter name	Conditions	Values
	This function allows extending the fan operation, dissipating heat in the environment and residual cool in the heat exchange coil. This function is active in both heating and cooling modes.	

There are other parameters to be added, which allow configuring the physical outputs' behaviour (relays or 0 ... 10V signal) depending on:

Control type and *General* ⇒ *Ventilation object format* or *General* ⇒ *Command object format*

Five different configuration cases are identified. Please see the table below to identify the proper configuration.

Control type	Ventilation object format	
	output status or counter	percentage
1-2-3 speeds (relays)	C1	C3
3 speeds (0...10V)	C2	C4
continuous regulation (0... 10V)		C5

C1 configuration

General ⇒ *Ventilation object format* = output status or counter

Control type = 1 speed (relay) or 2 speeds (relays) or 3 speeds (relays)

In this case, NO parameter has to be added: the speed is already determined by the output values or by the counter. If the counter is set to a higher speed than the set value, the value is ignored; e.g. if Control type = 2 speeds (relays) and counter value = 3, this value is ignored.

C2 configuration

General ⇒ *Ventilation object format* = output status or counter

Control type = 3 speeds (0... 10V)

In this case, the voltage value for each speed to be assigned to the output signals must be provided.

Parameter name	Conditions	Values
Output value at the first speed (*)	<i>General</i> ⇒ <i>Ventilation object format</i> = output status or counter Control type = 3 speeds (0... 10V)	20% [range 0.. 100%]
	(*) Parameter available only for EK-HB1-TP and EK-HC1-TP versions.	
Output value at the second speed (*)	<i>General</i> ⇒ <i>Ventilation object format</i> = output status or counter Control type = 3 speeds (0... 10V)	40% [range 0.. 100%]
	(*) Parameter available only for EK-HB1-TP and EK-HC1-TP versions.	
Output value at the third speed (*)	<i>General</i> ⇒ <i>Ventilation object format</i> = output status or counter Control type = 3 speeds (0... 10V)	70% [range 0.. 100%]
	(*) Parameter available only for EK-HB1-TP and EK-HC1-TP versions.	

C3 configuration

General ⇒ *Ventilation object format* = percentage

Control type = 1 speed (relay) or 2 speeds (relays) or 3 speeds (relays)

In this case, in order to activate a speed, the percentage value of the activation threshold must be provided; it is also necessary to specify a hysteresis value.

Parameter name	Conditions	Values
First speed threshold [%]	General ⇒ Ventilation object format = percentage Control type=1-2-3 speeds (relays)	10% [range 0.. 100%]
Second speed threshold [%]	General ⇒ Ventilation object format = percentage Control type=2-3 speeds (relays)	40% [range 0.. 100%]
Third speed threshold [%]	General ⇒ Ventilation object format = percentage Control type = 3 speeds (relays)	70% [range 0.. 100%]
Hysteresis [%]	General ⇒ Ventilation object format = percentage Control type=1-2-3 speeds (relays)	10% [range 0.. 20%]

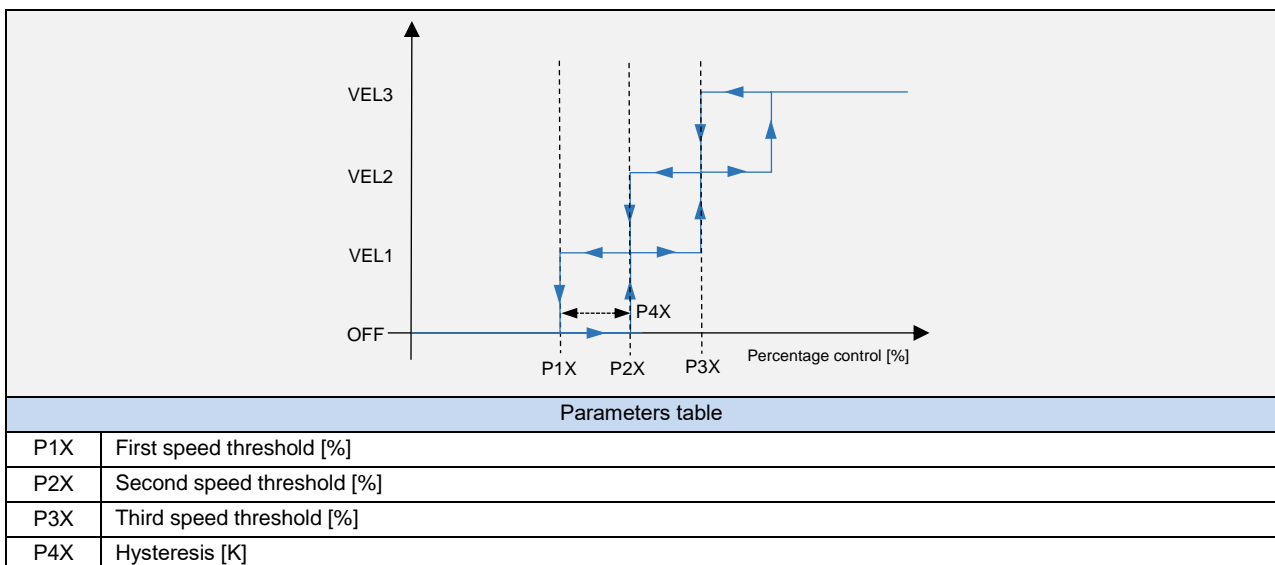

Configurazione C4

General ⇒ Ventilation object format = percentage

Control type = 3 speeds (0... 10V)

In this case, in order to activate a speed, the percentage value of the activation threshold must be provided; it is also necessary to specify a hysteresis value (like in C3 configuration). An output percentage for each speed (i.e. voltage to be sent on the output for each speed) must be also provided.

Parameter name	Conditions	Values
First speed threshold [%] (*)	General ⇒ Ventilation object format = percentage Control type = 3 speeds (0... 10V)	10% [range 0.. 100%]
	(*) Parameter available only for EK-HB1-TP and EK-HC1-TP versions.	
Second speed threshold [%] (*)	General ⇒ Ventilation object format = percentage Control type = 3 speeds (0... 10V)	40% [range 0.. 100%]
	(*) Parameter available only for EK-HB1-TP and EK-HC1-TP versions.	
Third speed threshold [%] (*)	General ⇒ Ventilation object format = percentage Control type = 3 speeds (0... 10V)	70% [range 0.. 100%]
	(*) Parameter available only for EK-HB1-TP and EK-HC1-TP versions.	
Hysteresis [%] (*)	General ⇒ Ventilation object format = percentage Control type = 3 speeds (0... 10V)	10% [range 0.. 20%]
	(*) Parameter available only for EK-HB1-TP and EK-HC1-TP versions.	

Parameter name	Conditions	Values
Output value at the first speed (*)	General ⇒ Ventilation object format = percentage Control type = 3 speeds (0... 10V)	20% [range 0.. 100%]
(*) Parameter available only for EK-HB1-TP and EK-HC1-TP versions.		
Output value at the second speed (*)	General ⇒ Ventilation object format = percentage Control type = 3 speeds (0... 10V)	40% [range 0.. 100%]
(*) Parameter available only for EK-HB1-TP and EK-HC1-TP versions.		
Output value at the third speed (*)	General ⇒ Ventilation object format = percentage Control type = 3 speeds (0... 10V)	70% [range 0.. 100%]
(*) Parameter available only for EK-HB1-TP and EK-HC1-TP versions.		

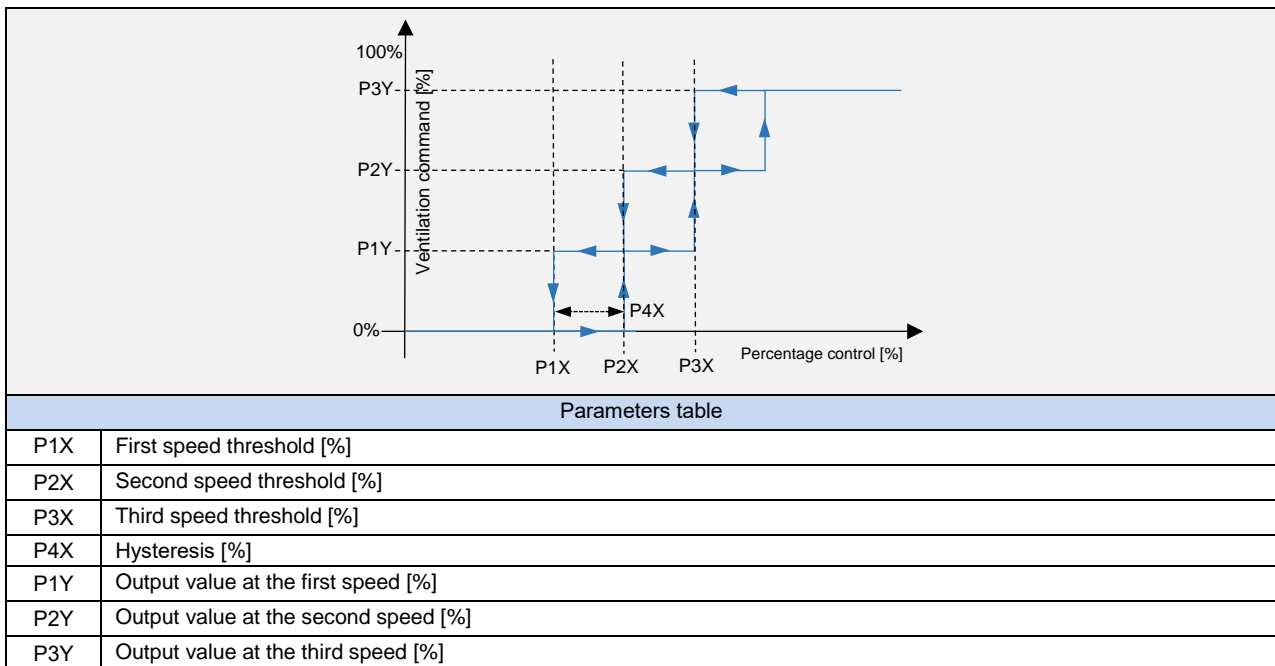

C5 configuration

General ⇒ Ventilation object format = percentage

Control type = continuous regulation (0... 10V)

Below a specific command CO value, the inverter is switched off; above a specific command CO value, the inverter is brought at 100%.

Parameter name	Conditions	Values
Min value to control [%] (*)	General ⇒ Ventilation object format = percentage Control type = continuous regulation (0... 10V)	15 % [range 0 ... 30 %]
(*) Parameter available only for EK-HB1-TP and EK-HC1-TP versions.		
Max value to control [%] (*)	General ⇒ Ventilation object format = percentage Control type = continuous regulation (0... 10V)	85 % [range 70 ... 100 %]
(*) Parameter available only for EK-HB1-TP and EK-HC1-TP versions.		
Low limit continuous speed (*)	General ⇒ Ventilation object format = percentage Control type = continuous regulation (0... 10V)	20 % [range 0 ... 30 %]
(*) Parameter available only for EK-HB1-TP and EK-HC1-TP versions.		
High limit continuous speed (*)	General ⇒ Ventilation object format = percentage Control type = continuous regulation (0... 10V)	90% [range 70 ... 100 %]
(*) Parameter available only for EK-HB1-TP and EK-HC1-TP versions.		

Object name	Conditions	Dim.	Flags	DPT	Comm. Obj. No.
Fan continuous speed command	General ⇒ Ventilation object format = percentage	1 Byte	C-W---	[5.001] percentage (0...100%)	0
Fan continuous speed command counter	General ⇒ Ventilation object format = counter	1 Byte	C-W---	[5.010] counter pulses (0...255)	0
First fan speed command	General ⇒ Ventilation object format = output status, Control type ≥ 1 speed (relay)	1 Bit	C-W---	[1.001] switch	0
Second fan speed command	General ⇒ Ventilation object format = output status, Control type ≥ 2 speeds (relays)	1 Bit	C-W---	[1.001] switch	1
Third fan speed command	General ⇒ Ventilation object format = output status, Control type = 3 speeds (relays)	1 Bit	C-W---	[1.001] switch	2
Fan disable from bus	Disable from bus = yes	1 Bit	C-W---	[1.003] enable	65
Fan speed limit enable	Fan speed limit from bus ≠ not limited	1 Bit	C-W---	[1.003] enable	82
Output V2 from bus	Control type = 1 speed (relay)	1 Bit	C-W---	[1.001] switch	77
	<i>This CO is automatically exposed in case the fan unit is configured to have only 1 speed, in order to assign the relay output to other functions: e.g. lighting control or ON/OFF actuations.</i>				
Output V3 from bus	Control type = 1 speed (relay) o Control type = 2 speeds (relays)	1 Bit	C-W---	[1.001] switch	78
	<i>This CO is automatically exposed in case the fan unit is configured to have 1-2 speeds, in order to assign the relay output to other functions: e.g. lighting control or ON/OFF actuations.</i>				

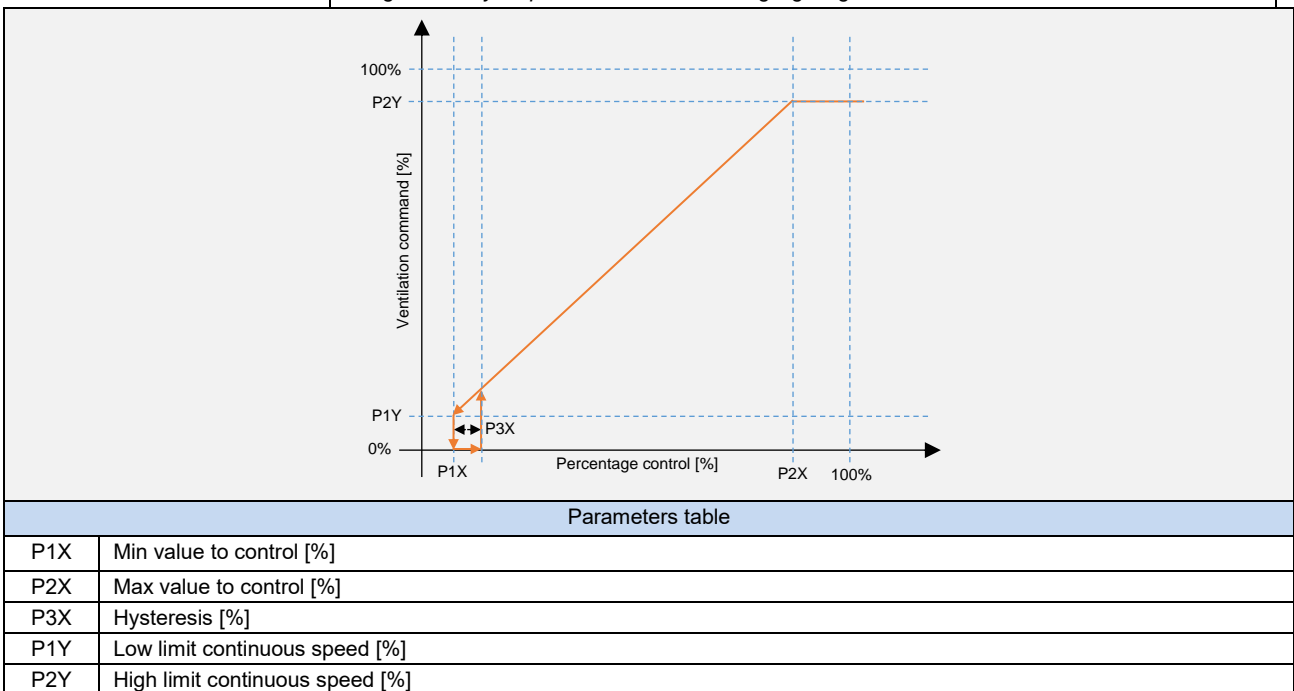

7.6 Heating valve

This folder allows setting the following parameters:

- the output default value in case of timeout after a command is issued;
- the activation of the valve protection function during inactivity periods.

This folder is enabled if *Controller* = external and

Application = convector or fan-coil and *Function* = heating or

Application = convector or fan-coil and *Function* = both heating and cooling and *Installation type* = 4 pipes (EK-HC1-TP version only)

If *Controller* = internal, this folder is not enabled and an equivalent folder is activated inside the *Temperature control* folder.

Parameter name	Conditions	Values
Valve position after timeout		OFF/ON
Control can be disabled from bus		no/yes
Signal	Control can be disabled from bus = yes	not inverted inverted
Antiscuff protection		disabled enabled
	<i>It enables the function that activates the drive for the valve control during periods of inactivity of the system.</i>	
Frequency	Antiscuff protection = enabled	once a day, once a week , once a month
Time interval	Antiscuff protection = enabled	10 s [other value in the range 5 s ... 20 min]

Object name	Conditions	Dim.	Flags	DPT	Comm. Obj. No.
Heating valve command (on/off)		1 Bit	C-W---	[1.001] switch	3
Heating valve disable from bus	Control can be disabled from bus = yes	1 Bit	C-W---	[1.003] enable	67

7.7 Cooling valve

This folder allows setting the following parameters:

- the output default value in case of timeout after a command is issued;
- the activation of the valve protection function during inactivity periods.

This folder is enabled if *Controller* = external and

Application = convector or fan-coil and *Function* = cooling or

Application = convector or fan-coil and *Function* = both heating and cooling and *Installation type* = 4 pipes (EK-HC1-TP version only)

If *Controller* = internal, this folder is not enabled and an equivalent folder is activated inside the *Temperature control* folder.

Parameter name	Conditions	Values
Valve position after timeout		OFF/ON
Control can be disabled from bus		no/yes
Signal	Control can be disabled from bus = yes	not inverted inverted
Antiscuff protection		disabled enabled
	<i>It enables the function that activates the drive for the valve control during periods of inactivity of the system.</i>	
Frequency	Antiscuff protection = enabled	once a day, once a week, once a month
Time interval	Antiscuff protection = enabled	10 s [other value in the range 5 s ... 20 min]

Object name	Conditions	Dim.	Flags	DPT	Comm. Obj. No.
Cooling valve command (on/off)		1 Bit	C-W---	[1.001] switch	4
Cooling valve disable from bus	Control can be disabled from bus = yes	1 Bit	C-W---	[1.003] enable	68

7.8 Heating/cooling valve

This folder allows setting the following parameters:

- the output default value in case of timeout after a command is issued;
- the activation of the valve protection function during inactivity periods.

This folder is enabled if *Controller* = external and

Application = convector or fan-coil and *Function* = cooling or

Application = convector or fan-coil and *Function* = both heating and cooling and *Installation type* = 2 pipes (EK-HC1-TP version only)

If *Controller* = internal, this folder is not enabled.

Parameter name	Conditions	Values
Valve position after timeout		OFF/ON
Control can be disabled from bus		no/yes
Signal	Control can be disabled from bus = yes	not inverted inverted
Antiscuff protection		disabled enabled
	<i>It enables the function that activates the drive for the valve control during periods of inactivity of the system.</i>	
Frequency	Antiscuff protection = enabled	once a day, once a week, once a month
Time interval	Antiscuff protection = enabled	10 s [other value in the range 5 s ... 20 min]

Object name	Conditions	Dim.	Flags	DPT	Comm. Obj. No.
Heating/cooling valve command (on/off)		1 Bit	C-W--	[1.001] switch	3
Heating/cooling valve disable from bus	Control can be disabled from bus = yes	1 Bit	C-W--	[1.003] enable	67

7.9 Auxiliary relays

This folder is available only for EK-HC1-TP version. This version is supplied with 2 outputs to command the intercept valves installed on the heating and cooling coils. In case of a single coil, the second output can be dedicated to control an electrical coil or a terminal activated in cooling mode only.

Parameter name	Conditions	Values
Auxiliary output type		value from bus active with heating request together with heating valve
Cyclic sending interval	Auxiliary output type = active on heating request or with heating valve	hh:mm:ss (00:00:00)
	<i>The value 00:00:00 means that the cyclic sending is not enabled and is therefore sent on change of state only.</i>	
Disable from bus	Auxiliary output type = active on heating request or with heating valve	no/yes
Signal	Disable from bus = yes	not inverted inverted

Object name	Conditions	Dim.	Flags	DPT	Comm. Obj. No.
Auxiliary relays disable from bus (*) (for EK-HC1-TP version)		1 Bit	C-W---	[1.003] enable	69
Auxiliary relays status (*) (for EK-HC1-TP version)		1 Bit	CR-T--	[1.001] switch	70

7.10 Drip tray level control

This folder allows customizing the drip tray system management during cooling operation, according to the following parameters:

- type of action when the maximum level in drip tray is reached (action on heat exchange coil valve and/or fan unit)
- cyclic sending of status (e.g. to activate a system to empty the drip tray)

This folder is active if *General* ⇒ *Application* = fan-coil.

The function is enabled if a sensor for drip level control is connected to a digital input (*Inputs* folder) or a communication object is acquired from bus in *External sensors (from bus)* folder.

Parameter name	Conditions	Values
Drip control		disabled enabled
	<i>In case no drip level sensor is enabled, the following information text appears: "For drip control function, enable the corresponding sensor in Inputs or External sensors (from bus) folder".</i>	
In case of drip	Drip control = enabled	close valve and switch fan off close valve and fan to min speed close valve and fan to max speed warning only
Cyclic sending interval	Drip control = enabled	no sending 3 min / 5 min / 10 min / 15 min / 20 min / 30 min / 60 min

Object name	Conditions	Dim.	Flags	DPT	Comm. Obj. No.
Drip tray contact (from input 1)	Inputs ⇒ Input 1 = [DI] Drip tray contact	1 Bit	CR-T--	[1.005] alarm	29
Drip tray contact (from input 2)	Inputs ⇒ Input 2 = [DI] Drip tray contact	1 Bit	CR-T--	[1.005] alarm	30
Drip tray contact (from input 3) (*)	Inputs ⇒ Input 3 = [DI] Drip tray contact	1 Bit	CR-T--	[1.005] alarm	31
<i>(*) Parameter available for EK-HB1-TP version only.</i>					
Drip tray contact (from bus)		1 Bit	CR-T--	[1.005] alarm	37
Drip tray status	External sensors (from bus) ⇒ Drip tray level = enabled	1 Bit	CR-T--	[1.005] alarm	73

In case more drip tray level sensors are connected to more inputs on terminal block or through C.O.s, the Drip tray status C.O. is a logical OR of all connected inputs.

7.11 Filter monitoring

Filter monitoring function calculates the usage time of ventilation and allows sending a warning after a preset usage time (in weeks) thus providing an indication of the need to substitute the air purification filters. It is possible to send on the bus a communication object indicating the total operation time of the fan unit (in hours or seconds).

This folder is active if

General ⇒ *Application* = ventilation or fan-coil

and if

General ⇒ *Report filter change* = yes.

Parameter name	Conditions	Values
Change filter warning after [weeks]		16 [field 1...128 weeks]
Send warning		on filter change only cyclic always
Send usage time		no sending (only reading) on change only on change and cyclic
Cyclic sending interval	Send usage time = On change only, or On change and cyclic sending	1 h / 2 h / 4 h / 24 h / 2 time for week / once for week
Communication Object type		seconds [DPT 13.100] hours [DPT 7.007]

Object name	Conditions	Dim.	Flags	DPT	Comm. Obj. No.
Fan working time (hours)	General ⇒ Report filter change = yes, Communication object type = hours [DPT 7.007]	2 Byte	CR-T--	[7.007] time (h)	62
	<div style="text-align: center;"> <p>Usage time is represented as unsigned integer with range [0...65535] hours.</p> </div>				
Fan working time (seconds)	General ⇒ Report filter change = yes, Communication object type = seconds [DPT 13.100]	4 Byte	CR-T--	[13.100] time lag (s)	63
Filter change warning	General ⇒ Report filter change = yes	1 Bit	CRWT--	[1.005] alarm	64
	<p><i>This CO has 2 functions. As sending object, it sends (cyclically or on change) a binary state ON when the number of weeks for the ventilation usage have been reached. As a receiving object, only when ON, it can be triggered to OFF: the effect is resetting Fan working time (hours) object.</i></p>				

7.12 Feedback (EK-HC1-TP only)

The *Feedback* folder is always visible and it is used to configure the status feedback for:

- Valve position: digital outputs DO1 (CO 13) and DO2 (CO 14);
- Fan control, with the following status objects:
 - Status 0-10V / Actual fan speed % (only if *General* ⇒ *Application* = *Ventilation* or *fan-coil* and if *Ventilation* ⇒ *Control type* = 3 *speed (0...10V)* or *continuous regulation* - CO 7
 - Fan stopped status - CO 8
 - Speed status V1 - CO 9
 - Speed status V2 - CO 10
 - Speed status V3 - CO 11
 - Counter speed fan status - CO 12

The cyclic sending period for these status feedback objects can be customized.

Parameter name	Conditions	Values
Valve position feedback		disabled / enabled
DO1: cyclic sending interval	Valve position feedback = enabled	no sending [other values in the range 30 s ... 60 min]
	<i>Enable/disable sending of the status of digital output DO1.</i>	
DO2: cyclic sending interval	Valve position feedback = enabled	no sending [other values in the range 30 s ... 60 min]
	<i>Enable/disable sending of the status of digital output DO2.</i>	
Fan control feedback		disabled / enabled
	<i>Enable/disable the feedback for the fan status.</i>	
Cyclic sending interval	Fan control feedback = enabled	no sending [other values in the range 30 s ... 60 min]
	<i>Cyclic sending period for the fan control status objects.</i>	
Minimum change of value to send [%]	Fan control feedback = enabled Ventilation ⇒ Control type = continuous regulation	5 [0 ... 30]
	<i>Minimum % variation of the fan status, so that the data is sent cyclically on the bus (if 0, it means that no cyclic sending occurs).</i>	

Object name	Conditions	Dim.	Flags	DPT	Comm. Obj. No.
Status 0-10V	General ⇒ Application = Convector, or General ⇒ Application = Ventilation or fan-coil, and Ventilation ⇒ Control type = 1, 2, 3 speed (relais)	1 Byte	CR-T--	[5.001] percentage (0...100%)	7
<i>Status feedback about the 0-10V control signal.</i>					
Actual fan speed %	General ⇒ Application = Ventilation or fan-coil, and Ventilation ⇒ Control type = 3 speed (0...10V) or continuous regulation	1 Byte	CR-T--	[5.001] percentage (0...100%)	7
<i>Status feedback about the fan speed percentage.</i>					
Fan stopped status	General ⇒ Application = Ventilation or fan-coil	1 Bit	CR-T--	[1.001] switch	8
<i>Status feedback about the fan activity (On/Off).</i>					
Speed status V1	-	1 Bit	CR-T--	[1.001] switch	9
<i>Status is On if the fan runs at speed 1.</i>					
Speed status V2	-	1 Bit	CR-T--	[1.001] switch	10
<i>Status is On if the fan runs at speed 2.</i>					
Speed status V3	-	1 Bit	CR-T--	[1.001] switch	11
<i>Status is On if the fan runs at speed 3.</i>					
Counter speed fan status	-	1 Byte	CR-T--	[5.010] counter pulses (0...255)	12
<i>Status feedback about the current fan speed (0, 1, 2, 3).</i>					
Valve DO1 status	-	1 Bit	CR-T--	[1.001] switch	13
<i>Status feedback of the current value for digital output DO1 (On/Off).</i>					
Valve DO2 status	-	1 Bit	CR-T--	[1.001] switch	14
<i>Status feedback of the current value for digital output DO2 (On/Off).</i>					

7.13 Temperature control

This folder is enabled if *Controller* = internal.

If *Controller* = external, the folder is active but empty.

7.13.1 Settings

The Settings folder contains the parameter allowing to perform the basic configuration of the room temperature controller:

- setpoint type: single or relative;
- operating mode change over;
- antiscuff protection activation.

Parameter name	Conditions	Values
Setpoint type		single relative
	<i>In case the option "Single" is selected and Function = heating, the temperature controller acts on heating mode; in case Function = cooling, the temperature controller acts on cooling mode. In case Function = both heating and cooling, the current seasonal mode needs to be specified by the proper communication object.</i>	
Setpoint CO type	Setpoint type = Relative	absolute relative
Cyclic sending interval		no sending [other values in the range 30 s ... 120 min]
	<i>In case Setpoint type = single, the actual setpoint value takes only into account the actual state of the contacts window (if the corresponding function is enabled). In case Setpoint type = relative, the actual setpoint value also depends on the operating mode set manually by the user or automatically by another KNX supervising device with the possibility of time scheduling.</i>	
Heating/cooling changeover	Function = both heating and cooling, Setpoint type = Relative	from bus automatic from room temperature (*) automatic from flow temperature
	<i>In case Setpoint type = single, the heating-cooling changeover must be carried out from bus. (*) This option is available in EK-HC1-TP version only (version with 2 outputs for valve command with possibility of 4-pipe installation type).</i>	
Temperature for changeover (heating)	Heating/cooling changeover = automatic from flow temperature; Input (X) = flow temperature sensor or External sensors (from bus) ⇒ Flow temperature = enabled,	35 [range 20°C ... 50°C]
Temperature for changeover (cooling)	Heating/cooling changeover = automatic from flow temperature; Input (X) = flow temperature sensor or External sensors (from bus) ⇒ Flow temperature = enabled,	16 [range 5°C ... 20°C]
Changeover cyclic sending interval	Function = both heating and cooling	no sending [other values in the range 30 s ... 120 min]
Antiscuff protection		disabled enabled
	<i>It enables the function that activates the drive for the valve control during periods of inactivity of the system.</i>	

Parameter name	Conditions	Values
Frequency	Antiscuff protection = enabled	once a day once a week once a month
Time interval	Antiscuff protection = enabled	10 s [other values in the range 5 s ... 20 min]

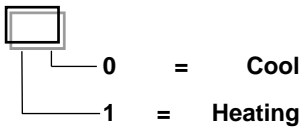
Object name	Conditions	Dim.	Flags	DPT	Comm. Obj. No.												
Thermal generator locked		1 Bit	C-W---	[1.005] alarm	18												
<p><i>This CO is used by an external device to stop the operation as actuator or controller. In case Controller = internal, when receiving the alarm, the internal temperature controller is deactivated.</i></p>																	
Temperature control alarm	Controller = internal	1 Bit	CR-T--	[1.005] alarm	19												
<p><i>Internal temperature controller alarm with regulation disabling. The alarm is activated on one of the following conditions:</i></p> <ul style="list-style-type: none"> • failure on one of the temperature sensors used for control • timeout when receiving the value of one of the temperature sensors used for control • drip tray alarm (if configured differently from simple warning) 																	
Actual setpoint		2 Byte	CR-T--	[9.001] temperature (°C)	48												
Heating/cooling status out	Always visible	1 Bit	CR-T--	[1.100] heating/cooling	42												
<p><i>The communication object is updated on the bus on event of change internally elaborated by the controller. The object is always exposed and contains the information about the current conduction mode of the internal temperature controller.</i></p> <p>[1.100] DPT Heat/Cool 1 Bit</p> 																	
Heating/cooling status in	Function = both heating and cooling, Heating/cooling changeover = from bus	1 Bit	C-W---	[1.100] heating/cooling	43												
<p><i>The communication object is received from the bus. At the switching event, the internal regulator switches the conduction mode.</i></p>																	
HVAC mode in	Setpoint type = Relative	1 Byte	C-W---	[20.102] HVAC mode	44												
<p><i>Bits 5 to 8 are reserved.</i></p> <p>[20.102] DPT HVAC Mode 1 Byte</p> <table style="width: 100%; text-align: center;"> <tr> <td>AUTO</td> <td>COMFORT</td> <td>STAND-BY</td> </tr> <tr> <td>0 0 0 0</td> <td>0 0 0 1</td> <td>0 0 1 0</td> </tr> <tr> <td>ECONOMY</td> <td>PROTECTION</td> <td></td> </tr> <tr> <td>0 0 1 1</td> <td>0 1 0 0</td> <td></td> </tr> </table>						AUTO	COMFORT	STAND-BY	0 0 0 0	0 0 0 1	0 0 1 0	ECONOMY	PROTECTION		0 0 1 1	0 1 0 0	
AUTO	COMFORT	STAND-BY															
0 0 0 0	0 0 0 1	0 0 1 0															
ECONOMY	PROTECTION																
0 0 1 1	0 1 0 0																
HVAC manual mode	Setpoint type = Relative	1 Byte	C-W---	[20.102] HVAC mode	45												
HVAC Chrono active status	Setpoint type = Relative	1 Bit	CRWTU-	[1.011] state	46												
HVAC mode out	Setpoint type = Relative	1 Byte	C-W---	[20.102] HVAC mode	47												

7.13.1.1 Monitoring and remote command of the conduction mode

The communication objects indicated in the block diagram allows monitoring and modifying the current conduction mode forced on the temperature controller. The object 20 – *Heating/cooling status out* is always exposed, even when the thermostat function is set on heating or cooling only. When the function is set on both heating and cooling, the cyclic sending on bus can be enabled; anyway, the information about the actual conduction mode can be acquired with a reading request to this communication object.

The object 43 – *Heating/cooling status in* is exposed only when the function is both heating and cooling and the switching among the different modes is performed by the bus.

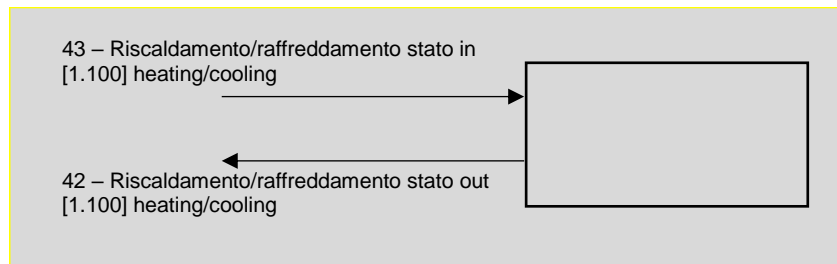

7.13.1.2 Remote operative mode modification

The communication objects shown in figure allow monitoring the operating mode (comfort, standby, economy and building protection) modifications performed by a supervisor software or the operating mode forced by chrono program.

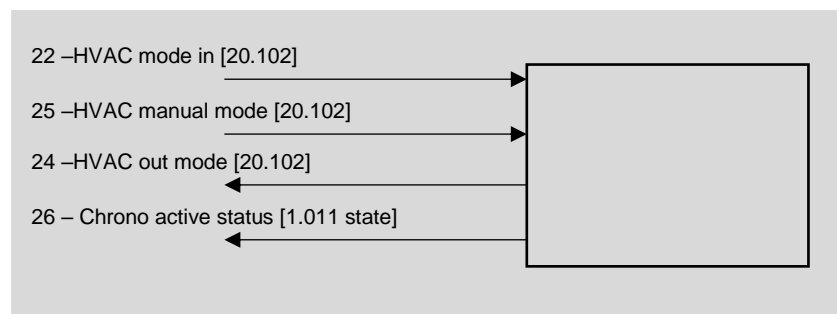

The C.O. 22 – *HVAC mode in* is associated to the chrono program. The C.O.s 24 – *HVAC mode out* and 26 – *HVAC chrono active status* allow the remote supervisor to discern the operating mode currently active on the room thermostat and also allow to understand if the chrono program is active or if attenuation is handled manually or not. The supervisor can set at any time a manual operating mode through C.O. 25 – *HVAC manual mode*; to start the chrono program remotely, the C.O. 25 – *HVAC manual mode* is to be set on value 0 = Automatic.

7.13.2 Heating

The *Heating* folder allows setting:

- the default value for single or relative setpoint (comfort setpoint and standby / economy attenuations);
- the type of regulation algorithm

This folder is active if *General* ⇒ *Controller* = internal and *General* ⇒ *Function* = heating or both heating and cooling.

Parameter name	Conditions	Values
Temperature setpoint [°C]	Setpoint type = Single	21 [range 10 ... 50]
Comfort setpoint [°C]	Setpoint type = Relative	21 [range 10 ... 50]
Standby offset [0,1 K]	Setpoint type = Relative,	- 30 [range -10 ... -50]
Economy offset [0,1 K]	Setpoint type = Relative	-50 [range -10 ... -50]
Building protection [°C]		7 [range 2 ... 10]
[...]	<i>Parameters about the type of regulation algorithm for the valves.</i>	
Control type		on/off, PWM (pulse width modulation)
Hysteresis	Control type = 2-point hysteresis	0,3 K [other values in the range 0,2 K ... 3 K]
PWM cycle time	Control type = PWM (pulse width modulation)	15 min [range 5 ... 240 min]
Min. control value [%]	Control type = PWM (pulse width modulation)	15 % [range 0 %...30 %]
Max. control value [%]	Control type = PWM (pulse width modulation)	85 % [range 70 %...100 %]
Proportional band [0,1 K]	Control type = PWM (pulse width modulation)	30 [range 0 ... 255]
Integral time [min]	Control type = PWM (pulse width modulation)	0 [range 0 ... 255 min]
Min. change of value to send [%]	Control type = PWM (pulse width modulation)	10 % [range 0 %...100 %]
<i>The duration of the ON command during a PWM cycle time is modified when the output percentage of the controller changes inside the range specified by this parameter.</i>		

Parameter name	Conditions	Values
[...]		
Cyclic sending interval		no sending [other values in the range 30 s ... 120 min]
	<i>This parameter allows cyclically sending on the bus the value of the temperature controller output (CO 61). Through this parameter, it is possible to send, in parallel, the output value to a different fan-coil device used as a simple actuator.</i>	
Forced mode		no/yes
	<i>This parameter allows commanding the controller output in manual / forced mode.</i>	
Control can be disabled from bus		no/yes
Signal	Control can be disabled from bus = yes	not inverted inverted
Valve position feedback		no/yes
	<i>In case of position feedback enabling without cyclic sending, the CO is updated when the device starts and on change of state.</i>	
Cyclic sending interval	Valve position feedback = yes	no sending [other values in the range 30 s ... 120 min]

Object name	Conditions	Dim.	Flags	DPT	Comm. Obj. No.
Actual setpoint		2 Byte	CR-T--	[9.001] temperature (°C)	48
Input setpoint	Setpoint type = Single	2 Byte	C-W---	[9.001] temperature (°C)	49
Comfort setpoint (heating)	Setpoint type = Relative	2 Byte	CRWTU-	[9.001] temperature (°C)	50
Standby offset (heating)	Setpoint type = Relative, Setpoint CO type = relative	2 Byte	CRWTU-	[9.002] temperature difference (K)	52
Standby setpoint (heating)	Setpoint type = Relative, Setpoint CO type = absolute	2 Byte	CRWTU-	[9.001] temperature (°C)	52
Standby offset (cooling)	Setpoint type = Relative, Setpoint CO type = relative	2 Byte	CRWTU-	[9.002] temperature difference (K)	54
Economy setpoint (heating)	Setpoint type = Relative, Setpoint CO type = absolute	2 Byte	CRWTU-	[9.001] temperature (°C)	54
Building protection (heating)		2 Byte	CRWTU-	[9.001] temperature (°C)	56
Controller output forced from bus	Heating ⇒ Forced mode = yes or Cooling ⇒ Forced mode = yes	1 Byte	C-W---	[5.001] percentage (0...100%)	71
Controller output automatic/forced from bus	Heating ⇒ Forced mode = yes or Cooling ⇒ Forced mode = yes	1 Bit	C-W---	[1.003] enable	72

Object name	Conditions	Dim.	Flags	DPT	Comm. Obj. No.
Manual/forced setpoint active status	Setpoint type = Relative	1 Bit	CRWTU-	[1.011] state	58
Manual setpoint	Setpoint type = Relative	2 Byte	CRWTU-	[9.001] temperature (°C)	59
Heating valve disable from bus	Control can be disabled from bus = yes and Function = Heating or both heating and cooling 4 pipes	1 Bit	C-W---	[1.003] enable	67
Heating/cooling valve disable from bus	Control can be disabled from bus = yes and Function = both heating and cooling 2 pipes	1 Bit	C-W---	[1.003] enable	67
Heating valve status	Valve position feedback = yes and Function = Heating or both heating and cooling 4 pipes	1 Bit	CR-T--	[1.001] switch	13
Heating/cooling valve status	Valve position feedback = yes and Function = both heating and cooling 2 pipes	1 Bit	CR-T--	[1.001] switch	13

7.13.2.1 Remote Setpoint modification

The communication objects shown in figure allow to monitor the Setpoint forced modifications performed remotely, for example from a supervisor software.

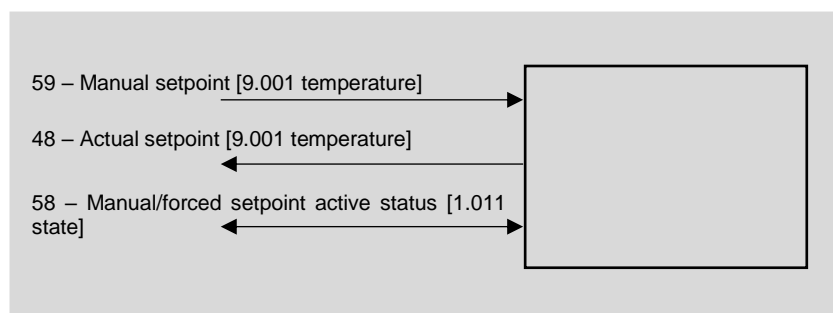
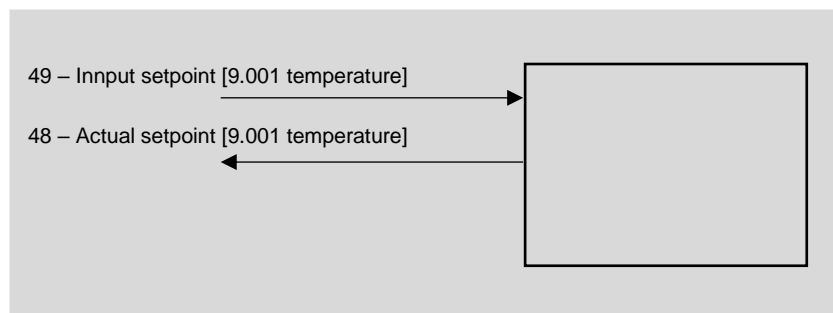

Those objects are about the Setpoint forced modification: alternatively, the supervisor can act directly on the operating mode setpoints (C.O. with index 50-57). The value of the C.O. 48 - *Actual setpoint* represents the current operative setpoint, which the control algorithms are based on. L'O.C. 58 - *Manual/forced setpoint active status* indicates if the forced mode is active. The supervisor can force at any time the actual setpoint by writing a new value directly into the C.O. 59 - *Manual setpoint*. The C.O. 58 - *Manual/forced setpoint active status* can also be used in writing to exit from the active forced mode.

7.13.2.2 Output manual command

It is possible to manually force the controller output to a desired percentage value in order to test the ventilation. The forcing requires to take the controller output to Forced mode in the first place, then it is possible to select a controller output in a 0-100% range. Likewise, in order to go back to automatic operation, the CO 72 - *Controller output automatic/forced from bus* must be written.

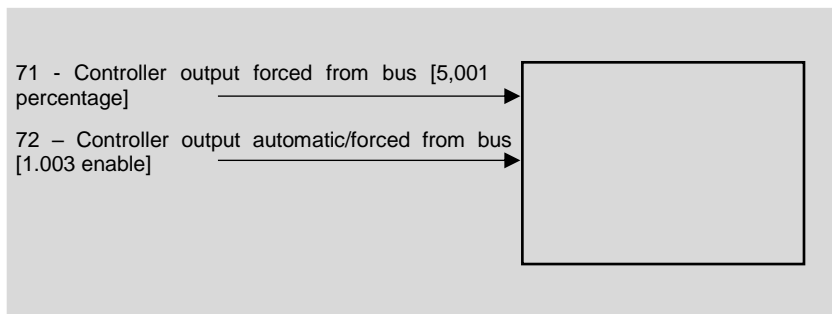

7.13.3 Cooling

The *Cooling* folder allows setting:

- the default values for single or relative setpoints (comfort setpoint and standby / economy attenuations) in case of manual heating-cooling changeover;
- the default value for the dead-band for changeover and for standby / economy attenuations in case of automatic, based on internal conditions heating-cooling changeover;
- the type of regulation algorithm (2-point hysteresis, PWM) and internal parameters to control the valve.

This folder is active if *General* ⇒ *Controller* = internal and

General ⇒ *Function* = cooling or both heating and cooling.

Parameter name	Conditions	Values
Temperature setpoint [°C]	Setpoint type = Single	23 [range 10 ... 50]
Dead Band for change-over [0,1 K] (*)	Setpoint type = Relative, Heating/cooling changeover = automatic	20 [range 10 ... 40]
	(*) Parameter available for EK-HC1-TP version only	
Comfort setpoint [°C]	Setpoint type = Relative, Heating/cooling changeover = from bus	23 [range 10 ... 50]
Standby offset [0,1 K]	Setpoint type = Relative,	30 [range 10 ... 50]
Economy offset [0,1 K]	Setpoint type = Relative	50 [range 10 ... 80]
Building protection [°C]		36 [range 20 ... 50]
[...]		
	<i>Parameters about the type of regulation algorithm for the valves.</i>	
Control type		on/off, PWM (pulse width modulation)
Hysteresis	Control type = 2-point hysteresis	0,3 K [other value in the range 0,2 K ... 3 K]
PWM cycle time	Control type = PWM (pulse width modulation)	15 min [range 5 ... 240 min]
Min. control value [%]	Control type = PWM (pulse width modulation)	15 % [range 0 %...30 %]
Max. control value [%]	Control type = PWM (pulse width modulation)	85 % [range 70 %...100 %]
Proportional band [0,1 K]	Control type = PWM (pulse width modulation)	30 [range 0 ... 255]

Parameter name	Conditions	Values
Integral time [min]	Control type = PWM (pulse width modulation)	0 [range 0 ... 255 min]
Min change of value to send [%]	Control type = PWM (pulse width modulation)	10 % [range 0 %...100 %]
[...]	<i>The duration of the ON command during a PWM cycle time is modified when the output percentage of the controller changes inside the range specified by this parameter.</i>	
Cyclic sending interval		no sending [other values in the range 30 s ... 120 min]
	<i>This parameter allows cyclically sending on the bus the value of the temperature controller output (CO 61). Through this parameter, it is possible to send, in parallel, the output value to a different fan-coil device used as a simple actuator.</i>	
Forced mode		no/yes
	<i>This parameter allows commanding the controller output in manual / forced mode.</i>	
Control can be disabled from bus (*)		no/yes
	<i>(*) Parameter available for EK-HC1-TP version only, in 4-pipes installation systems. In EK-HA1-TP version, the parameter is available in the Heating folder.</i>	
Signal (*)	Control can be disabled from bus = yes	not inverted inverted
	<i>(*) Parameter available for EK-HC1-TP version only, in 4-pipes installation systems. In EK-HA1-TP version, the parameter is available in the Heating folder.</i>	
Valve position feedback (*)		no/yes
	<i>In case of position feedback enabling without cyclic sending, the CO is updated when the device starts and on change of state. (*) Parameter available for EK-HC1-TP version only, in 4-pipes installation systems. In EK-HA1-TP version, the parameter is available in the Heating folder.</i>	
Cyclic sending interval (*)	Valve position feedback = yes	no sending [other values in the range 30 s ... 120 min]
	<i>(*) Parameter available for EK-HC1-TP version only, in 4-pipes installation systems. Nella versione EK-HA1-TP, il parametro è impostabile nella scheda Heating</i>	

Object name	Conditions	Dim.	Flags	DPT	Comm. Obj. No.
Actual setpoint		2 Byte	CR-T--	[9.001] temperature (°C)	48
Input setpoint	Setpoint type = Single	2 Byte	C-W---	[9.001] temperature (°C)	49
Comfort setpoint (cooling)	Setpoint type = Relative	2 Byte	CRWTU-	[9.001] temperature (°C)	51
Standby offset (cooling)	Setpoint type = Relative, Setpoint CO type = relative	2 Byte	CRWTU-	[9.002] temperature difference (K)	53
Standby setpoint (cooling)	Setpoint type = Relative, Setpoint CO type = absolute	2 Byte	CRWTU-	[9.001] temperature (°C)	53
Economy offset (cooling)	Setpoint type = Relative, Setpoint CO type = relative	2 Byte	CRWTU-	[9.002] temperature difference (K)	55
Economy setpoint (cooling)	Setpoint type = Relative, Setpoint CO type = absolute	2 Byte	CRWTU-	[9.001] temperature (°C)	55

Object name	Conditions	Dim.	Flags	DPT	Comm. Obj. No.
Building protection (cooling)		2 Byte	CRWTU-	[9.001] temperature (°C)	57
Controller output forced from bus	Heating ⇒ Forced mode = yes or Cooling ⇒ Forced mode = yes	1 Byte	C-W---	[5.001] percentage (0...100%)	71
Controller output automatic/forced from bus	Heating ⇒ Forced mode = yes or Cooling ⇒ Forced mode = yes	1 Bit	C-W---	[1.003] enable	72
Manual/forced setpoint active status	Setpoint type = Relative	1 Bit	CRWTU-	[1.011] state	58
Manual setpoint	Setpoint type = Relative	2 Byte	CRWTU-	[9.001] temperature (°C)	59
Cooling valve disable from bus (*)	Control can be disabled from bus = yes and Function = Heating or both heating and cooling 4 pipes	1 Bit	C-W---	[1.003] enable	68
<i>(*) Parameter available for EK-HC1-TP version only, in 4-pipes installation systems.</i>					

Setpoint remote modification and output manual command use the same settings as the Heating conduction mode; for a correct use of the exposed Cos, please refer to function blocks reported in the *Heating* section.

7.13.4 External temperature compensation

Temperature compensation can be performed in two ways:

- acquiring the external temperature by means of a sensor connected to an analog input. The device can send the acquired value to other fan-coil controller on the bus;
- acquiring the external temperature from bus by means of a KNX temperature sensor suitable for outdoor installation.

The folder is active if *General* ⇒ *Function* = Cooling or both heating and cooling and if an external temperature sensor is connected.

Parameter name	Conditions	Values
Summer compensation		disabled enabled
Lowest external temperature [°C]		25 [°C] [range 25 ... 40 °C]
Coefficient		1 K each 8 K external temp. change 1 K each 7 K external temp. change 1 K each 6 K external temp. change 1 K each 5 K external temp. change 1 K each 4 K external temp. change 1 K each 3 K external temp. change 1 K each 2 K external temp. change 1 K each 1 K external temp. change
Min change to send value [K]		0,6 K [range 0 ... +5 K]
	<i>0 means no value sent on change.</i>	
Cyclic sending interval		no sending [other values in the range 30 s ... 120 m]

Object name	Conditions	Dim.	Flags	DPT	Comm. Obj. No.
Actual setpoint		2 Byte	CR-T--	[9.001] temperature (°C)	48
Cooling compensation offset		2 Byte	CR-T--	[9.002] temperature difference (K)	60

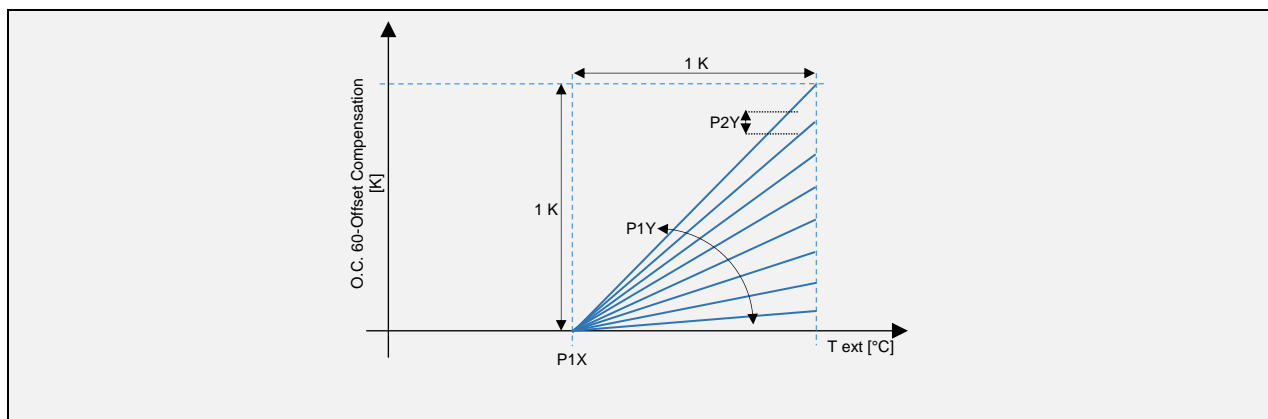

Parameters table

P1X	Lowest external temperature [$^{\circ}\text{C}$]
P1Y	Coefficient
P2Y	Min change to send value [K]

7.13.5 Ventilation

The *Ventilation* folder contains:

- the setting parameters for relays or continuous command outputs (for EK-HB1-TP and EK-HC1-TP versions) and the parameters for the output behaviour based on the values of the commands received from bus;
- the cold start settings;
- the warm start settings;
- the 2-sensor antistratification settings;
- the time-scheduled antistratification settings;
- the fan activation and deactivation delays;
- the speed limitation activation (e.g. at night);
- the activation of the ventilation speed feedback.

These situations are different from the situations and parameters already seen when the device is acting as actuator. The main difference is that, when acting as actuator, the *Speed threshold N [%]* is in percentage, while when acting as a controller, the *Speed threshold N [K]* is in Kelvin degrees as error between operation setpoint and measured temperature.

The ventilation folder is active if *General* ⇒ *Controller* = external and *General* ⇒ *Application* = ventilation or fan-coil.

Parameter name	Conditions	Values
Control type		1 speed (relay) 2 speeds (relays) 3 speeds (relays) 3 speeds (0...10V) (*) continuous regulation (0... 10V) (*)
	(*) Options available in EK-HB1-TP and EK-HC1-TP versions.	
[...]	Setting parameters depending on the adopted configuration. Please see the different situation in the following sections.	
Warm start	General ⇒ Function = Heating or both heating and cooling, Inputs ⇒ Input X ⇒ [AI] coil battery temperature sensor or External sensors (from bus) ⇒ Coil temperature = enabled	no/yes
	In order to perform the function, at least one sensor for measuring the water temperature at the fan-coil heat exchange coil must be enabled. It can be either an input configured as analog or an external sensor (from bus).	
Heat exchange coil temperature [°C]	Warm start = yes	35 [range 28 ... 40]
Cold start	General ⇒ Function = Cooling or both heating and cooling, Inputs ⇒ Input X ⇒ [AI] coil battery temperature sensor or External sensors (from bus) ⇒ Coil temperature = enabled	no/yes
Heat exchange coil temperature [°C]	Cold start = yes	12 [range 7 ... 18]

Parameter name	Conditions	Values
Fan control	Warm start = yes and/or Cold start = yes	depending on the temperature continuous
	<p><i>Depending on temperature: the switching off of the fan is bound to two conditions: i) achieving the room temperature setpoint ii) the temperature measured at the exchange coil is lower (heating) or higher (cooling) to the value set in the parameter "Heat exchange coil temperature [°C]"</i></p> <p><i>Continuous: the operation of the fan is bound to the temperature measured at the exchange coil. When heating it allows to dissipate in the room the residual heat present in the exchange coil.</i></p>	
2-sensor antistratification	Inputs ⇒ Input X ⇒ [AI] antistratification temperature sensor or External sensors (from bus) ⇒ Antistratification temperature = enabled	disabled enabled
	<p><i>In order to perform the function, at least one sensor for measuring a second room temperature value, at a different quote from the thermostat, must be enabled. It can be either an input configured as analog or an external sensor (from bus).</i></p>	
Temperature differential	2-sensor antistratification = enabled	2 [K/m] [other values in the range 0,25 ... 4,00]
	<p><i>DIN 1946 advises not to go above a 2 K/m value for average height (between 2,70 and 3 m) environments.</i></p>	
Hysteresis	2-sensor antistratification = enabled	0,6 K [other values in the range 0,2 ... 3 K]
Disable from bus		no/yes
Signal	Disable from bus = yes	not inverted inverted
Fan speed limit from bus	Control type > 1 speed	not limited speed 1 speed 2
	<p><i>This parameter allows forcing a preset, constant speed from bus. The typical application is a hotel, where noises during the night must be kept to minimum.</i></p>	
Start delay		0 s [other values in the range 10 s ... 12 min]
	<p><i>Also displayed if warm start function mode through water temperature measurement on heat exchange coil is used. This function is active in both heating and cooling modes.</i></p>	
Stop delay		0 s [other values in the range 10 s ... 12 min]
	<p><i>This function allows extending the fan operation, dissipating heat in the environment and residual cool in the heat exchange coil. This function is active in both heating and cooling modes.</i></p>	
Control feedback		no/yes
	<p>Options available in EK-HA1-TP and EK-HB1-TP versions only. For EK-HC1-TP, please see paragraph 7.12.</p>	
Cyclic sending interval	Abilita feedback di velocità ventilante = yes	no sending [other values in the range 30 s ... 120 min]

Parameter name	Conditions	Values
Time-scheduled antistratification	Inputs \Rightarrow Input X \Rightarrow [AI] room temperature sensor or External sensors (from bus) \Rightarrow Room temperature = enabled	disabled enabled
<i>In order to perform the function, one sensor for measuring a room temperature value must be enabled. It can be either an input configured as analog or an external sensor (from bus).</i>		
Frequency	Time-scheduled antistratification = enabled	30 min [other values in the range 5 ... 60 min]
Time interval	Time-scheduled antistratification = enabled	2 min [other values in the range 30 s ... 5 min]

Three different configuration cases are identified. Please see the table below to identify the proper configuration.

Control type	
1-2-3 speeds (relays)	C1
3 speeds (0...10V)	C2
continuous regulation (0... 10V)	C3

C1 configuration

Control type = 1 speed (relay), 2 speeds (relays) and 3 speeds (relays).

Parameter name	Conditions	Values
First speed threshold [0,1 K]	Control type = 1-2-3 speeds (relays)	10 [range 0 ... 255]
Second speed threshold [0,1 K]	Control type = 2-3 speeds (relays)	20 [range 0 ... 255]
Third speed threshold [0,1 K]	Control type = 3 speeds (relays)	30 [range 0 ... 255]
Hysteresis [K]	Control type = 1-2-3 speeds (relays)	0,3 K [other values in the range 0,2 K ... 3 K]

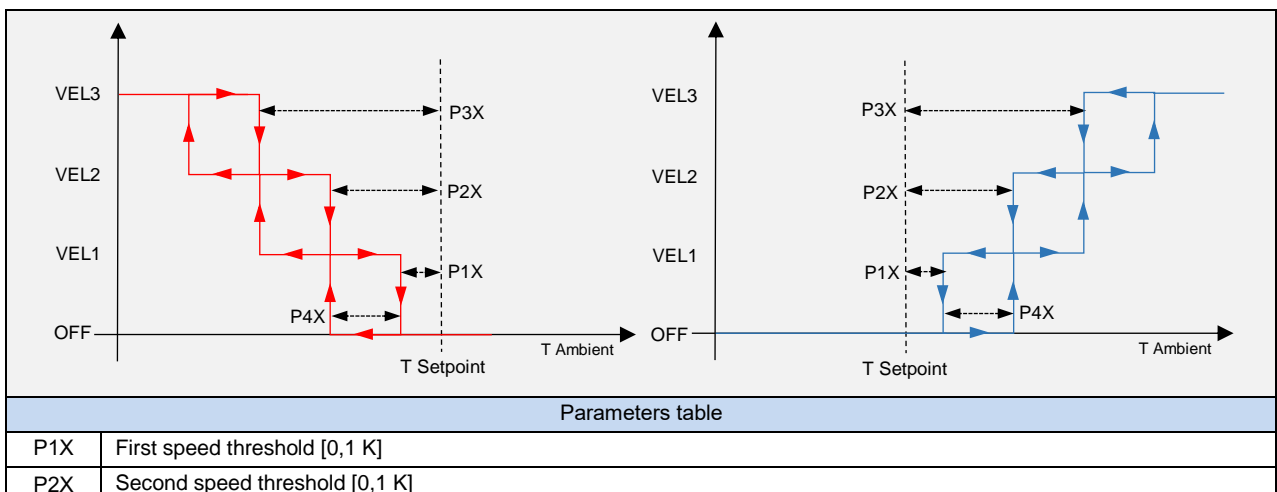

P3X	Third speed threshold [0,1 K]
P4X	Hysteresis [K]

C2 configuration

Control type = 3 speeds (0...10V)

In this case, in order to activate a speed, the percentage value of the activation threshold must be provided; it is also necessary to specify a hysteresis value (like in C1 configuration). An output percentage for each speed (i.e. voltage to be sent on the output for each speed) must be also provided.

Parameter name	Conditions	Values
First speed threshold [0,1 K]	Control type = 3 speeds (0...10V)	10 [range 0 ... 255]
Second speed threshold [0,1 K]	Control type = 3 speeds (0...10V)	20 [range 0 ... 255]
Third speed threshold [0,1 K]	Control type = 3 speeds (0...10V)	30 [range 0 ... 255]
Hysteresis [K]	Control type = 3 speeds (0...10V)	0,3 K [other values in the range 0,2 K ... 3 K]
Output value at the first speed	Control type = 3 speeds (0...10V)	10% [range 0.. 100%]
Output value at the second speed	Control type = 3 speeds (0...10V)	40% [range 0.. 100%]
Output value at the third speed	Control type = 3 speeds (0...10V)	70% [range 0.. 100%]

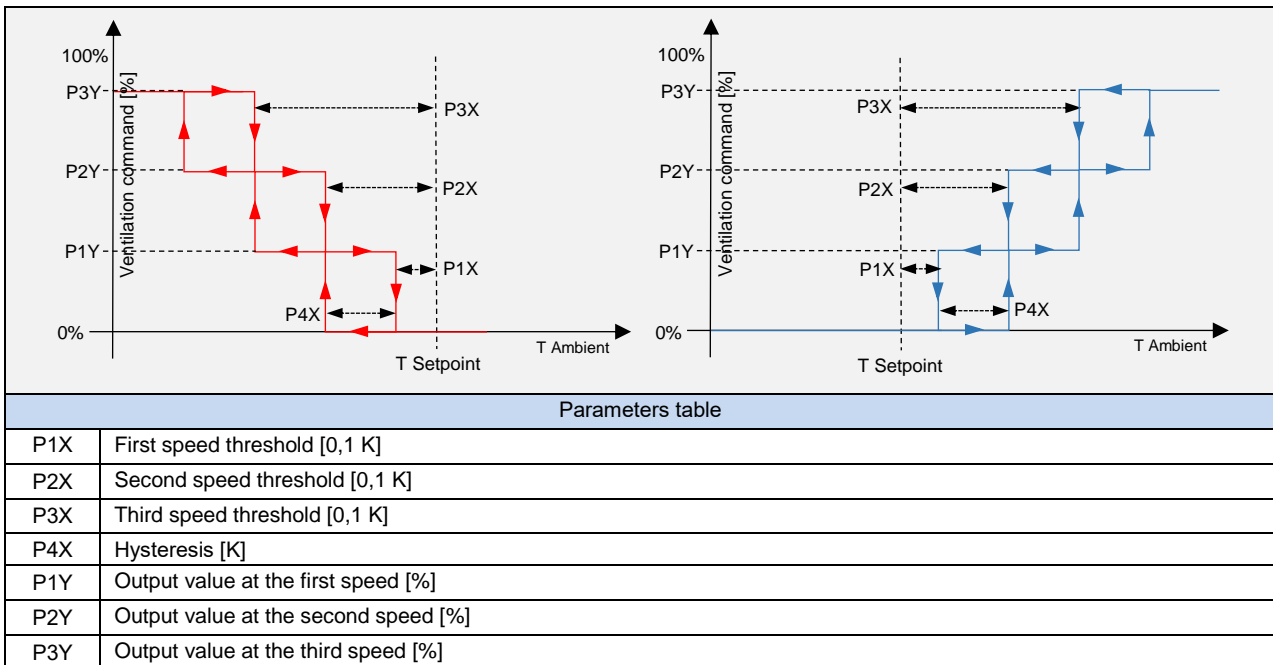

C3 configuration

Control type = continuous regulation (0... 10V).

Option available for EK-HB1-TP and EK-HC1-TP versions. Below a specific command CO value, the inverter is switched off; above a specific command CO value, the inverter is brought at 100%.

Proportional band [0,1 K]	Control type = continuous regulation (0... 10V)	30 [range 0 ... 255]
Integral time [min]	Control type = continuous regulation (0... 10V)	0 [range 0 ... 255]
Min value to control [%]	Control type = continuous regulation (0... 10V)	0 % [range 0 ... 100 %]
Max value to control [%]	Control type = continuous regulation (0... 10V)	100 % [range 0 ... 100 %]
Hysteresis [%]		5 % [range 0 ... 30 %]
Low limit continuous speed [%]	Control type = continuous regulation (0... 10V)	0 % [range 0 ... 100 %]
High limit continuous speed [%]	Control type = continuous regulation (0... 10V)	100% [range 0 ... 100 %]

Object name	Conditions	Dim.	Flags	DPT	Comm. Obj. No.
Continuous speed fan status (*)	Control feedback = yes	1 Byte	CR-T--	[5.001] percentage (0...100%)	7
	(*) Options available in EK-HB1-TP versions only. For EK-HC1-TP, please see paragraph 7.12.				
Fan stopped status	Control feedback = yes	1 Bit	CR-T--	[1.001] switch	8
	Option available in EK-HA1-TP and EK-HB1-TP versions only. For EK-HC1-TP, please see paragraph 7.12.				
First fan speed status	Control feedback = yes	1 Bit	CR-T--	[1.001] switch	9
	Option available in EK-HA1-TP and EK-HB1-TP versions only. For EK-HC1-TP, please see paragraph 7.12.				
Second fan speed status	Control feedback = yes	1 Bit	CR-T--	[1.001] switch	10
	Option available in EK-HA1-TP and EK-HB1-TP versions only. For EK-HC1-TP, please see paragraph 7.12..				
Third fan speed status	Control feedback = yes	1 Bit	CR-T--	[1.001] switch	11
	Option available in EK-HA1-TP and EK-HB1-TP versions only. For EK-HC1-TP, please see paragraph 7.12.				
Counter speed fan status	Control feedback = yes	1 Byte	CR-T--	[5.010] counter pulses (0...255)	12
	Option available in EK-HA1-TP and EK-HB1-TP versions only. For EK-HC1-TP, please see paragraph 7.12.				
Fan continuous speed manual command (*)	General ⇒ Application = ventilation or fan-coil Ventilation ⇒ Control type = continuous regulation	1 Byte	C-W---	[5.001] percentage (0...100%)	0

Object name	Conditions	Dim.	Flags	DPT	Comm. Obj. No.
(*) Option available in EK-HB1-TP and EK-HC1-TP versions only. For EK-HC1-TP, please see paragraph 7.12.					
Fan continuous speed manual counter	General \Rightarrow Application = ventilation or fan-coil Ventilation \Rightarrow Control type = 1, 2, 3 speed (relais) or 3 speed (0...10V)	1 Byte	C-W---	[5.010] counter pulses (0...255)	1
Fan manual/auto status		1 Bit	CRWTU-	[1.011] state	66
Fan speed limit enable	Fan speed limit from bus \Leftrightarrow not limited	1 Bit	C-W---	[1.003] enable	82
Fan disable from bus	Disable from bus = enabled	1 Bit	C-W---	[1.003] enable	65

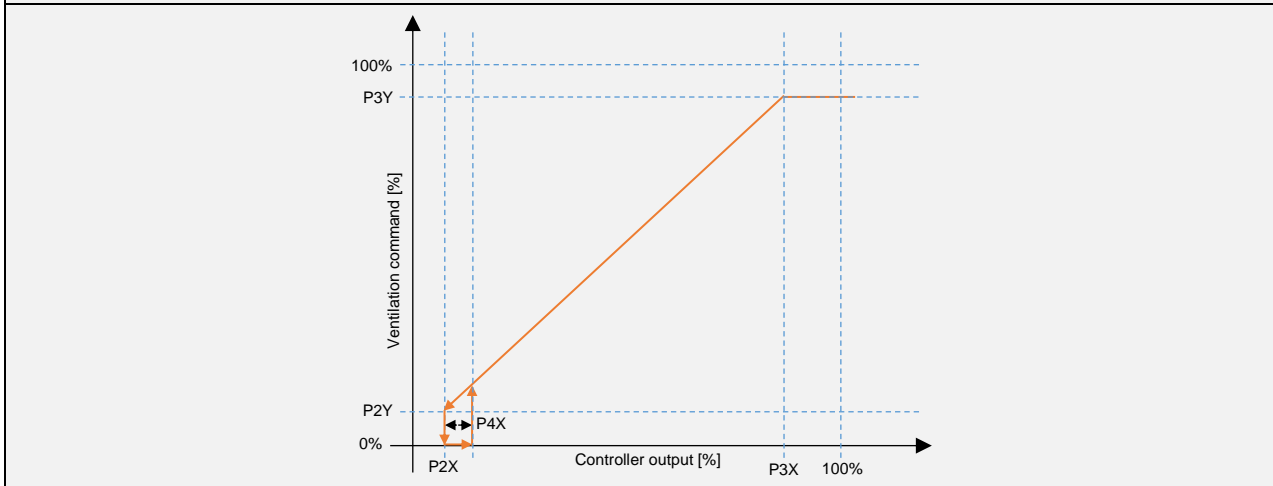
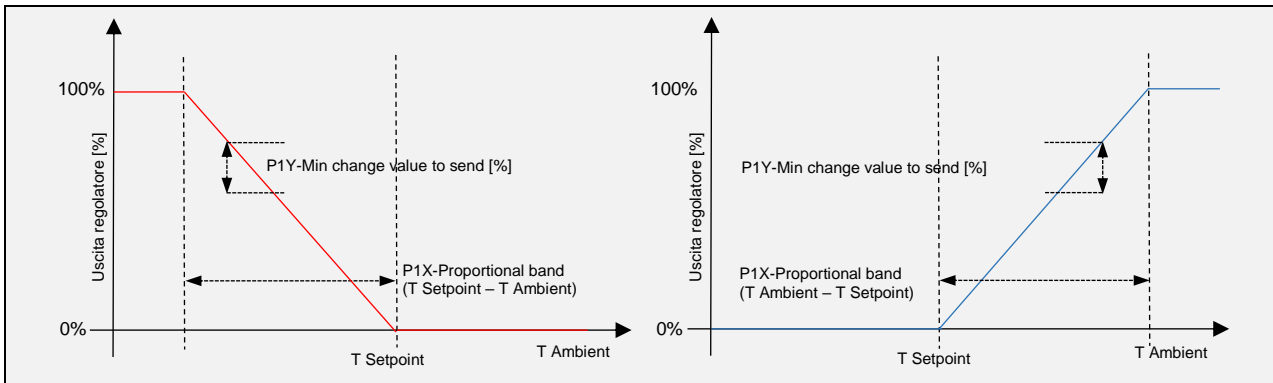

Parameters table

P1X	Proportional band [0,1 K]
P2X	Min value to control [%]
P3X	Max value to control [%]
P4X	Hysteresis [%]
P1Y	Min change value to send [%]
P2Y	Low limit continuous speed [%]
P3Y	High limit continuous speed [%]

7.13.5.1 Remote fan speed modification

The communication objects shown in figure allow to monitor actual fan speed forced automatically (A) by the temperature controller or set manually. The communication objects also allow performing the same modifications remotely, for example from a supervisor software.

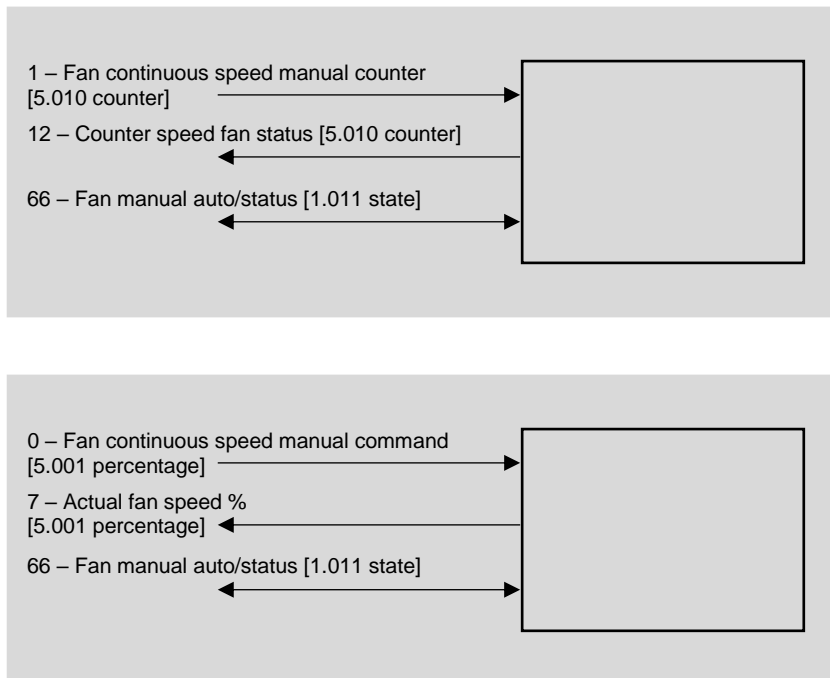

The C.O. 7/12 – *Counter speed fan status* allows to evaluate the actual fan speed; the C.O. 66 – *Fan manual/auto status* contains the information about automatic (=0, not active) or manual (=1, active) operating mode. By modifying the C.O. 0/1 – *Fan manual speed*, the fan automatically switches to the setpoint speed; to return to automatic mode (A), the supervisor must exit from manual mode by modifying the C.O. 66 – *Fan manual auto/status* (=0, not active).

Accepted values for C.O.s 1/12 depend on the number of speeds set in ETS.

If *Control Type* parameter in Ventilation folder = 1, 2 or 3 speeds, C.O.s with DPT [5.010 counter] accept the following values:

- = 0: OFF
- = 1: speed 1
- = 2: speed 2 (if *Control Type* > 1 speed)
- = 3: speed 3 (if *Control Type* > 2 speed)

If *Control Type* parameter in Ventilation folder = continuous regulation, the values of the C.O.s with DPT [5.010 counter] match the following percentage of the maximum speed:

- = 0: OFF
- = 1: 20%
- = 2: 40%
- = 3: 60%
- = 4: 80%
- = 5: 100%

7.13.6 Windows contacts

This folder is active if the controller is set on internal and a window contact is connected to a terminal block input (Inputs folder) or if a contact is detected through 1-2 communication objects (*External sensors (from bus)* folder). In case of multiple window contacts connected to more than one terminal block or input and through acquisition of a communication object, the device detects the open window state and recalls the building protection operating mode by performing a logical OR of all inputs.

Parameter name	Conditions	Values
Window contacts function		disabled enabled
Time to wait before HVAC change	Window contacts function = enabled	00:01:00 hh:mm:ss [range 00:00:00 ... 18:12:15]
	Time interval before the automatic switching of the device to the Building protection operating mode	

Object name	Conditions	Dim.	Flags	DPT	Comm. Obj. No.
Window contact (from input 1)	Window contacts function = enabled, Inputs ⇒ Input 1 = [DI] window contact sensor	1 Bit	CR-T-	[1.019] window/door	29
Window contact (from input 2)	Window contacts function = enabled, Inputs ⇒ Input 2 = [DI] window contact sensor	1 Bit	CR-T-	[1.019] window/door	29
Window contact (from input 3) (*)	Window contacts function = enabled, Inputs ⇒ Input 3 = [DI] window contact sensor	1 Bit	CR-T-	[1.019] window/door	29
(*) Parameter available for EK-HC1-TP version only.					
Window contact 1 (from bus)	Window contacts function = enabled, Window contact 1 = enabled	1 Bit	C-W--	[1.019] window/door	38
Window contact 2 (from bus)	Window contacts function = enabled, Window contact 2 = enabled	1 Bit	C-W--	[1.019] window/door	39

7.13.7 Presence sensors

This folder is active if the controller is set on internal and 1-2 presence sensors are connected through the relative communication objects (*External sensors (from bus)* folder). In case of 2 presence sensors connected, the device detects the comfort extension or limitation state by performing a logical OR of all input COs.

Parameter name	Conditions	Values
Presence sensors function		disabled enabled
Parameter that enables the presence sensor function.		
Use	Presence sensor function = enabled	comfort extension comfort limitation comfort extension and comfort limitation
Modes	Presence sensor function = enabled, Presence sensors use = comfort extension and comfort limitation or = comfort limitation	comfort-standby comfort-economy
Time to wait before HVAC change	Presence sensor function = enabled	00:01:00 hh:mm:ss [range 00:00:00 ... 18:12:15]
Time interval before the automatic switching of the operating mode set in the Thermostat modes parameter.		

Object name	Conditions	Dim.	Flags	DPT	Comm. Obj. No.
Presence sensor 1 (from bus)	External sensors (from bus) ⇒ Presence sensor 1 = enabled	1 Bit	C-W---	[1.018] occupancy	40
Presence sensor 2 (from bus)	External sensors (from bus) ⇒ Presence sensor 2 = enabled	1 Bit	C-W---	[1.018] occupancy	41

7.14 Logic functions

The actuator/controller (EK-HC1-TP version) allows using some useful logic functions (AND, OR, NOT and exclusive OR) in order to implement complex functions in the building automation system.

You can configure:

- 8 channels of logical functions
- 4 inputs for each channel

Each object value, if desired, can be individually inverted by inserting a NOT logic operator.

For each channel, a parameter *Delay after bus voltage recovery* is available: this parameter represents the time interval between the bus voltage recovery and the first reading of the input communication objects for evaluating the logic functions.



In case of incorrect connection of the input communication object or electrical trouble on bus resulting in a failed input reading request, the logic output of the corresponding channel can be calculated by setting the input values to default.

The communication function representing the logic function output is sent on the bus on event of change; alternatively, a cyclic sending can be set.

The folder is enabled if: *General* ⇒ *Logic functions* = enabled.

Parameter name	Conditions	Values
Logic function		enabled / disabled
Logic operation	Logic function = enabled	OR / AND / XOR
	<i>XOR (eXclusive OR)</i>	
Delay after bus voltage recovery		00:00:04.000 hh:mm:ss.fff [range 00:00:00.000 ... 00:10:55.350]
	<i>Time interval between the bus voltage recovery and the first reading of the input communication objects for evaluating the logic functions.</i>	
Cyclic sending interval		no sending [other values in the range 30 s ... 120 min]
	<i>No sending means that the output state of the logic function is updated on the bus only on change. Different values imply cyclic sending on the bus of the output state.</i>	
Logic object x		enabled / disabled
Negated	Logic object x = enabled	no / yes
	<i>By negating the logic state of the corresponding object, it is possible to create complex combinatory logics. For example: Output= (NOT(Logic object 1) OR Logic object 2).</i>	
Start reading	Logic object x = enabled	no / yes
Default value	Logic object x = enabled	none / off / on

Object name		Conditions	Dim.	Flags	DPT	Comm. Obj. No.
Logic function X, Input 1		Logic function X = enabled Logic object 1 = enabled	1 Bit	C-W--	[1.001] switch	84, 89, 94, 99, 104, 109, 114, 119
Logic function X, Input 2		Logic function X = enabled Logic object 2 = enabled	1 Bit	C-W--	[1.001] switch	85, 90, 95, 100, 105, 110, 115, 120
Logic function X, Input 3		Logic function X = enabled Logic object 3 = enabled	1 Bit	C-W--	[1.001] switch	86, 91, 96, 101, 106, 111, 116, 121
Logic function X, input 4		Logic function X = enabled Logic object 4 = enabled	1 Bit	C-W--	[1.001] switch	87, 92, 97, 102, 107, 112, 117, 122
Logic function X, output		Logic function X = enabled	1 Bit	C-W--	[1.001] switch	88, 93, 98, 103, 108, 113, 118, 123

8 Appendix

8.1 List of communications objects

The following list contains the KNX communication objects for all corresponding *Data Point Types* (DPT) defined by the application program according to the performed configurations.

The list is ordered by object number; if the same object is linked to different inputs, the first input or rocker is referenced.

8.1.1 Communications object for EK-HA1-TP and EK-HB1-TP

Nr.	Name	Size	Flags	Datapoint type
0	Fan continuous speed command	1 Byte	-WC---	[5.1] DPT_Scaling
0	Fan continuous speed manual (for EK-HB1-TP)	1 Byte	-WC---	[5.1] DPT_Scaling
0	Fan continuous speed command counter	1 Byte	-WC---	[5.10] DPT_Value_1_Ucount
0	First fan speed command	1 Bit	-WC---	[1.1] DPT_Switch
1	Second fan speed command	1 Bit	-WC---	[1.1] DPT_Switch
1	Fan continuous speed manual counter	1 Byte	-WC---	[5.10] DPT_Value_1_Ucount
2	Third fan speed command	1 Bit	-WC---	[1.1] DPT_Switch
3	Heating valve command (on/off)	1 Bit	-WC---	[1.1] DPT_Switch
3	Heating/cooling valve command (on/off)	1 Bit	-WC---	[1.1] DPT_Switch
4	Cooling valve command (on/off)	1 Bit	-WC---	[1.1] DPT_Switch
5	Heating/cooling changeover command	1 Bit	-WC---	[1.100] DPT_Heat_Cool
6	Test mode activated	1 Bit	R-CT--	[1.3] DPT_Enable
7	Continuous speed fan status	1 Byte	R-CT--	[5.1] DPT_Scaling
8	Fan stopped status	1 Bit	R-CT--	[1.1] DPT_Switch
9	First fan speed status	1 Bit	R-CT--	[1.1] DPT_Switch
10	Second fan speed status	1 Bit	R-CT--	[1.1] DPT_Switch
11	Third fan speed status	1 Bit	R-CT--	[1.1] DPT_Switch
12	Counter speed fan status	1 Byte	R-CT--	[5.10] DPT_Value_1_Ucount
13	Heating valve status	1 Bit	R-CT--	[1.1] DPT_Switch
13	Heating/cooling valve status	1 Bit	R-CT--	[1.1] DPT_Switch
15	Technical alarm	1 Bit	R-CT--	[1.5] DPT_Alarm
16	Communication alarm	1 Bit	R-CT--	[1.5] DPT_Alarm
18	Thermal generator locked	1 Bit	-WC---	[1.5] DPT_Alarm
19	Temperature control alarm	1 Bit	R-CT--	[1.5] DPT_Alarm
20	Room temperature sensor (from input 1)	2 Bytes	R-CT--	[9.1] DPT_Value_Temp
20	Outdoor temperature sensor (from input 1)	2 Bytes	R-CT--	[9.1] DPT_Value_Temp
20	Coil battery temperature sensor (from input 1)	2 Bytes	R-CT--	[9.1] DPT_Value_Temp
20	Antistratification temperature sensor (from input 1)	2 Bytes	R-CT--	[9.1] DPT_Value_Temp
20	Flow temperature sensor (from input 1)	2 Bytes	R-CT--	[9.1] DPT_Value_Temp
20	Temperature value sensor (from input 1)	2 Bytes	R-CT--	[9.1] DPT_Value_Temp
21	Temperature threshold 1 sensor (from input 1) - Switch	1 Bit	R-CT--	[1.1] DPT_Switch
22	Temperature threshold 2 sensor (from input 1) - Switch	1 Bit	R-CT--	[1.1] DPT_Switch

Nr.	Name	Size	Flags	Datapoint type
23	Room temperature sensor (from input 2)	2 Bytes	R-CT--	[9.1] DPT_Value_Temp
23	Outdoor temperature sensor (from input 2)	2 Bytes	R-CT--	[9.1] DPT_Value_Temp
23	Coil battery temperature sensor (from input 2)	2 Bytes	R-CT--	[9.1] DPT_Value_Temp
23	Antistratification temperature sensor (from input 2)	2 Bytes	R-CT--	[9.1] DPT_Value_Temp
23	Flow temperature sensor (from input 2)	2 Bytes	R-CT--	[9.1] DPT_Value_Temp
23	Temperature value sensor (from input 2)	2 Bytes	R-CT--	[9.1] DPT_Value_Temp
24	Temperature threshold 1 sensor (from input 2) - Switch	1 Bit	R-CT--	[1.1] DPT_Switch
25	Temperature threshold 2 sensor (from input 2) - Switch	1 Bit	R-CT--	[1.1] DPT_Switch
29	Generic contact (from input 1)	1 Bit	R-CT--	[1.1] DPT_Switch
29	Window contact (from input 1)	1 Bit	R-CT--	[1.19] DPT_Window_Door
29	Drip tray contact (from input 1)	1 Bit	R-CT--	[1.5] DPT_Alarm
30	Generic contact (from input 2)	1 Bit	R-CT--	[1.1] DPT_Switch
30	Window contact (from input 2)	1 Bit	R-CT--	[1.19] DPT_Window_Door
30	Drip tray contact (from input 2)	1 Bit	R-CT--	[1.5] DPT_Alarm
32	Room temperature (from bus)	2 Bytes	-WC---	[9.1] DPT_Value_Temp
33	Outdoor temperature (from bus)	2 Bytes	-WC---	[9.1] DPT_Value_Temp
34	Coil battery temperature (from bus)	2 Bytes	-WC---	[9.1] DPT_Value_Temp
35	Antistratification temperature (from bus)	2 Bytes	-WC---	[9.1] DPT_Value_Temp
36	Water supply temperature (from bus)	2 Bytes	-WC---	[9.1] DPT_Value_Temp
37	Drip tray contact (from bus)	1 Bit	-WC---	[1.5] DPT_Alarm
38	Window contact 1 (from bus)	1 Bit	-WC---	[1.19] DPT_Window_Door
39	Window contact 2 (from bus)	1 Bit	-WC---	[1.19] DPT_Window_Door
40	Presence sensor 1 (from bus)	1 Bit	-WC---	[1.18] DPT_Occupancy
41	Presence sensor 2 (from bus)	1 Bit	-WC---	[1.18] DPT_Occupancy
42	Heating/cooling status out	1 Bit	R-CT--	[1.100] DPT_Heat_Cool
43	Heating/cooling status in	1 Bit	-WC---	[1.100] DPT_Heat_Cool
44	HVAC mode in	1 Byte	-WC---	[20.102] DPT_HVACMode
45	HVAC manual mode	1 Byte	-WC---	[20.102] DPT_HVACMode
46	HVAC Chrono active status	1 Bit	RWCTU-	[1.11] DPT_State
47	HVAC mode out	1 Byte	R-CT--	[20.102] DPT_HVACMode
48	Actual setpoint	2 Bytes	R-CT--	[9.1] DPT_Value_Temp
49	Input setpoint	2 Bytes	-WC---	[9.1] DPT_Value_Temp
50	Comfort setpoint (heating)	2 Bytes	RWCTU-	[9.1] DPT_Value_Temp
51	Comfort setpoint (cooling)	2 Bytes	RWCTU-	[9.1] DPT_Value_Temp
52	Standby offset (heating)	2 Bytes	RWCTU-	[9.2] DPT_Value_Tempd
52	Standby setpoint (heating)	2 Bytes	RWCTU-	[9.1] DPT_Value_Temp
53	Standby offset (cooling)	2 Bytes	RWCTU-	[9.2] DPT_Value_Tempd
53	Standby setpoint (cooling)	2 Bytes	RWCTU-	[9.1] DPT_Value_Temp
54	Economy offset (heating)	2 Bytes	RWCTU-	[9.2] DPT_Value_Tempd
54	Economy setpoint (heating)	2 Bytes	RWCTU-	[9.1] DPT_Value_Temp
55	Economy offset (cooling)	2 Bytes	RWCTU-	[9.2] DPT_Value_Tempd

Nr.	Name	Size	Flags	Datapoint type
55	Economy setpoint (cooling)	2 Bytes	RWCTU-	[9.1] DPT_Value_Temp
56	Building protection (heating)	2 Bytes	RWCTU-	[9.1] DPT_Value_Temp
57	Building protection (cooling)	2 Bytes	RWCTU-	[9.1] DPT_Value_Temp
58	Manual/forced setpoint active status	1 Bit	RWCTU-	[1.11] DPT_State
59	Manual setpoint	2 Bytes	RWCTU-	[9.1] DPT_Value_Temp
60	Cooling compensation offset	2 Bytes	R-CT--	[9.2] DPT_Value_Tempd
61	Temperature controller output	1 Byte	R-CT--	[5.1] DPT_Scaling
62	Fan working time (hours)	2 Bytes	R-CT--	[7.7] DPT_Time_Hours
63	Fan working time (seconds)	4 Bytes	R-CT--	[13.1] DPT_LongDeltaTimeSec
64	Filter change warning	1 Bit	RWCT-	[1.5] DPT_Alarm
65	Fan disable from bus	1 Bit	-WC---	[1.3] DPT_Enable
66	Fan manual/auto status	1 Bit	RWCTU-	[1.11] DPT_State
67	Heating valve disable from bus	1 Bit	-WC---	[1.3] DPT_Enable
67	Heating/cooling valve disable from bus	1 Bit	-WC---	[1.3] DPT_Enable
71	Controller output forced from bus	1 Byte	-WC---	[5.1] DPT_Scaling
72	Controller output automatic/forced from bus	1 Bit	-WC---	[1.3] DPT_Enable
73	Drip tray status	1 Bit	R-CT--	[1.5] DPT_Alarm
75	Power off alarm	1 Bit	R-CT--	[1.5] DPT_Alarm
76	Output V1 from bus	1 Bit	-WC---	[1.1] DPT_Switch
77	Output V2 from bus	1 Bit	-WC---	[1.1] DPT_Switch
78	Output V3 from bus	1 Bit	-WC---	[1.1] DPT_Switch
79	Output DO1 from bus	1 Bit	-WC---	[1.1] DPT_Switch
81	Output 0-10V from bus (for EK-HB1-TP)	1 Byte	-WC---	[5.1] DPT_Scaling
82	Fan speed limit enable	1 Bit	-WC---	[1.3] DPT_Enable
83	Alarm text	14 Bytes	R-CT--	[16.0] DPT_String_ASCII
84, 89, 94, 99, 104, 109, 114, 119	Logic Function X, Input 1	1 Bit	-WC---	[1.1] DPT_Switch
85, 90, 95, 100, 105, 110, 115, 120	Logic Function X, Input 2	1 Bit	-WC---	[1.1] DPT_Switch
86, 91, 96, 101, 106, 111, 116, 121	Logic Function X, Input 3	1 Bit	-WC---	[1.1] DPT_Switch
87, 92, 97, 102, 107, 112, 117, 122	Logic Function X, Input 4	1 Bit	-WC---	[1.1] DPT_Switch
88, 93, 98, 103, 108, 113, 118, 123	Logic Function X, Output	1 Bit	R-CT--	[1.1] DPT_Switch

8.1.2 Communications object for EK-HC1-TP

Nr.	Name	Size	Flags	Datapoint type
0	Fan continuous speed command	1 Byte	-WC---	[5.1] DPT_Scaling
0	Fan continuous speed command counter	1 Byte	-WC---	[5.10] DPT_Value_1_Ucount
0	Fan continuous speed manual command	1 Byte	-WC---	[5.1] DPT_Scaling
0	First fan speed command	1 Bit	-WC---	[1.1] DPT_Switch
1	Second fan speed command	1 Bit	-WC---	[1.1] DPT_Switch
1	Fan continuous speed manual counter	1 Byte	-WC---	[5.10] DPT_Value_1_Ucount
2	Third fan speed command	1 Bit	-WC---	[1.1] DPT_Switch
3	Heating valve command (on/off)	1 Bit	-WC---	[1.1] DPT_Switch
3	Heating/cooling valve command (on/off)	1 Bit	-WC---	[1.1] DPT_Switch
4	Cooling valve command (on/off)	1 Bit	-WC---	[1.1] DPT_Switch
5	Heating/cooling changeover command	1 Bit	-WC---	[1.100] DPT_Heat_Cool
6	Test mode activated	1 Bit	R-CT--	[1.3] DPT_Enable
7	Actual fan speed %	1 Byte	R-CT--	[5.1] DPT_Scaling
7	Status 0-10V	1 Byte	R-CT--	[5.1] DPT_Scaling
8	Fan stopped status	1 Bit	R-CT--	[1.1] DPT_Switch
9	Speed status V1	1 Bit	R-CT--	[1.1] DPT_Switch
10	Speed status V2	1 Bit	R-CT--	[1.1] DPT_Switch
11	Speed status V3	1 Bit	R-CT--	[1.1] DPT_Switch
12	Counter speed fan status	1 Byte	R-CT--	[5.10] DPT_Value_1_Ucount
13	Valve DO1 status	1 Bit	R-CT--	[1.1] DPT_Switch
14	Valve DO2 status	1 Bit	R-CT--	[1.1] DPT_Switch
15	Technical alarm	1 Bit	R-CT--	[1.5] DPT_Alarm
16	Communication alarm	1 Bit	R-CT--	[1.5] DPT_Alarm
18	Thermal generator locked	1 Bit	-WC---	[1.5] DPT_Alarm
19	Temperature control alarm	1 Bit	R-CT--	[1.5] DPT_Alarm
20	Room temperature sensor (from input 1)	2 Bytes	R-CT--	[9.1] DPT_Value_Temp
20	Outdoor temperature sensor (from input 1)	2 Bytes	R-CT--	[9.1] DPT_Value_Temp
20	Coil battery temperature sensor (from input 1)	2 Bytes	R-CT--	[9.1] DPT_Value_Temp
20	Antistratification temperature sensor (from input 1)	2 Bytes	R-CT--	[9.1] DPT_Value_Temp
20	Flow temperature sensor (from input 1)	2 Bytes	R-CT--	[9.1] DPT_Value_Temp
20	Temperature value sensor (from input 1)	2 Bytes	R-CT--	[9.1] DPT_Value_Temp
21	Temperature threshold 1 sensor (from input 1) - Switch	1 Bit	R-CT--	[1.1] DPT_Switch
22	Temperature threshold 2 sensor (from input 1) - Switch	1 Bit	R-CT--	[1.1] DPT_Switch
23	Room temperature sensor (from input 2)	2 Bytes	R-CT--	[9.1] DPT_Value_Temp
23	Outdoor temperature sensor (from input 2)	2 Bytes	R-CT--	[9.1] DPT_Value_Temp
23	Coil battery temperature sensor (from input 2)	2 Bytes	R-CT--	[9.1] DPT_Value_Temp
23	Antistratification temperature sensor (from input 2)	2 Bytes	R-CT--	[9.1] DPT_Value_Temp
23	Flow temperature sensor (from input 2)	2 Bytes	R-CT--	[9.1] DPT_Value_Temp
23	Temperature value sensor (from input 2)	2 Bytes	R-CT--	[9.1] DPT_Value_Temp
24	Temperature threshold 1 sensor (from input 2) - Switch	1 Bit	R-CT--	[1.1] DPT_Switch

Nr.	Name	Size	Flags	Datapoint type
25	Temperature threshold 2 sensor (from input 2) - Switch	1 Bit	R-CT--	[1.1] DPT_Switch
26	Room temperature sensor (from input 3)	2 Bytes	R-CT--	[9.1] DPT_Value_Temp
26	Outdoor temperature sensor (from input 3)	2 Bytes	R-CT--	[9.1] DPT_Value_Temp
26	Coil battery temperature sensor (from input 3)	2 Bytes	R-CT--	[9.1] DPT_Value_Temp
26	Antistratification temperature sensor (from input 3)	2 Bytes	R-CT--	[9.1] DPT_Value_Temp
26	Flow temperature sensor (from input 3)	2 Bytes	R-CT--	[9.1] DPT_Value_Temp
26	Temperature value sensor (from input 3)	2 Bytes	R-CT--	[9.1] DPT_Value_Temp
27	Temperature threshold 1 sensor (from input 3) - Switch	1 Bit	R-CT--	[1.1] DPT_Switch
28	Temperature threshold 2 sensor (from input 3) - Switch	1 Bit	R-CT--	[1.1] DPT_Switch
29	Generic contact (from input 1)	1 Bit	R-CT--	[1.1] DPT_Switch
29	Window contact (from input 1)	1 Bit	R-CT--	[1.19] DPT_Window_Door
29	Drip tray contact (from input 1)	1 Bit	R-CT--	[1.5] DPT_Alarm
30	Generic contact (from input 2)	1 Bit	R-CT--	[1.1] DPT_Switch
30	Window contact (from input 2)	1 Bit	R-CT--	[1.19] DPT_Window_Door
30	Drip tray contact (from input 2)	1 Bit	R-CT--	[1.5] DPT_Alarm
31	Generic contact (from input 3)	1 Bit	R-CT--	[1.1] DPT_Switch
31	Window contact (from input 3)	1 Bit	R-CT--	[1.19] DPT_Window_Door
31	Drip tray contact (from input 3)	1 Bit	R-CT--	[1.5] DPT_Alarm
32	Room temperature (from bus)	2 Bytes	-WC---	[9.1] DPT_Value_Temp
33	Outdoor temperature (from bus)	2 Bytes	-WC---	[9.1] DPT_Value_Temp
34	Coil battery temperature (from bus)	2 Bytes	-WC---	[9.1] DPT_Value_Temp
35	Antistratification temperature (from bus)	2 Bytes	-WC---	[9.1] DPT_Value_Temp
36	Water supply temperature (from bus)	2 Bytes	-WC---	[9.1] DPT_Value_Temp
37	Drip tray contact (from bus)	1 Bit	-WC---	[1.5] DPT_Alarm
38	Window contact 1 (from bus)	1 Bit	-WC---	[1.19] DPT_Window_Door
39	Window contact 2 (from bus)	1 Bit	-WC---	[1.19] DPT_Window_Door
40	Presence sensor 1 (from bus)	1 Bit	-WC---	[1.18] DPT_Occupancy
41	Presence sensor 2 (from bus)	1 Bit	-WC---	[1.18] DPT_Occupancy
42	Heating/cooling status out	1 Bit	R-CT--	[1.100] DPT_Heat_Cool
43	Heating/cooling status in	1 Bit	-WC---	[1.100] DPT_Heat_Cool
44	HVAC mode in	1 Byte	-WC---	[20.102] DPT_HVACMode
45	HVAC manual mode	1 Byte	-WC---	[20.102] DPT_HVACMode
46	HVAC Chrono active status	1 Bit	RWCTU-	[1.11] DPT_State
47	HVAC mode out	1 Byte	R-CT--	[20.102] DPT_HVACMode
48	Actual setpoint	2 Bytes	R-CT--	[9.1] DPT_Value_Temp
49	Input setpoint	2 Bytes	-WC---	[9.1] DPT_Value_Temp
50	Comfort setpoint (heating)	2 Bytes	RWCTU-	[9.1] DPT_Value_Temp
51	Comfort setpoint (cooling)	2 Bytes	RWCTU-	[9.1] DPT_Value_Temp
52	Standby offset (heating)	2 Bytes	RWCTU-	[9.2] DPT_Value_Tempd
52	Standby setpoint (heating)	2 Bytes	RWCTU-	[9.1] DPT_Value_Temp
53	Standby offset (cooling)	2 Bytes	RWCTU-	[9.2] DPT_Value_Tempd

Nr.	Name	Size	Flags	Datapoint type
53	Standby setpoint (cooling)	2 Bytes	RWCTU-	[9.1] DPT_Value_Temp
54	Economy offset (heating)	2 Bytes	RWCTU-	[9.2] DPT_Value_Tempd
54	Economy setpoint (heating)	2 Bytes	RWCTU-	[9.1] DPT_Value_Temp
55	Economy offset (cooling)	2 Bytes	RWCTU-	[9.2] DPT_Value_Tempd
55	Economy setpoint (cooling)	2 Bytes	RWCTU-	[9.1] DPT_Value_Temp
56	Building protection (heating)	2 Bytes	RWCTU-	[9.1] DPT_Value_Temp
57	Building protection (cooling)	2 Bytes	RWCTU-	[9.1] DPT_Value_Temp
58	Manual/forced setpoint active status	1 Bit	RWCTU-	[1.11] DPT_State
59	Manual setpoint	2 Bytes	RWCTU-	[9.1] DPT_Value_Temp
60	Cooling compensation offset	2 Bytes	R-CT--	[9.2] DPT_Value_Tempd
61	Temperature controller output	1 Byte	R-CT--	[5.1] DPT_Scaling
62	Fan working time (hours)	2 Bytes	R-CT--	[7.7] DPT_Time_Hours
63	Fan working time (seconds)	4 Bytes	R-CT--	[13.1] DPT_LongDeltaTimeSec
64	Filter change warning	1 Bit	RWCT-	[1.5] DPT_Alarm
65	Fan disable from bus	1 Bit	-WC---	[1.3] DPT_Enable
66	Fan manual/auto status	1 Bit	RWCTU-	[1.11] DPT_State
67	Heating valve disable from bus	1 Bit	-WC---	[1.3] DPT_Enable
67	Heating/cooling valve disable from bus	1 Bit	-WC---	[1.3] DPT_Enable
68	Cooling valve disable from bus	1 Bit	-WC---	[1.3] DPT_Enable
69	Auxiliary relays disable from bus	1 Bit	-WC---	[1.3] DPT_Enable
70	Auxiliary relays status	1 Bit	R-CT--	[1.1] DPT_Switch
71	Controller output forced from bus	1 Byte	-WC---	[5.1] DPT_Scaling
72	Controller output automatic/forced from bus	1 Bit	-WC---	[1.3] DPT_Enable
73	Drip tray status	1 Bit	R-CT--	[1.5] DPT_Alarm
74	Disable front keyboard	1 Bit	-WC---	[1.2] DPT_Bool
75	Power off alarm	1 Bit	R-CT--	[1.5] DPT_Alarm
76	Output V1 from bus	1 Bit	-WC---	[1.1] DPT_Switch
77	Output V2 from bus	1 Bit	-WC---	[1.1] DPT_Switch
78	Output V3 from bus	1 Bit	-WC---	[1.1] DPT_Switch
79	Output DO1 from bus	1 Bit	-WC---	[1.1] DPT_Switch
80	Output DO2 from bus	1 Bit	-WC---	[1.1] DPT_Switch
81	Output 0-10V from bus	1 Byte	-WC---	[5.1] DPT_Scaling
82	Fan speed limit enable	1 Bit	-WC---	[1.3] DPT_Enable
83	Alarm text	14 Bytes	R-CT--	[16.0] DPT_String_ASCII
84, 89, 94, 99, 104, 109, 114, 119	Logic Function X, Input 1	1 Bit	-WC---	[1.1] DPT_Switch
85, 90, 95, 100, 105, 110, 115, 120	Logic Function X, Input 2	1 Bit	-WC---	[1.1] DPT_Switch
86, 91, 96, 101, 106, 111, 116, 121	Logic Function X, Input 3	1 Bit	-WC---	[1.1] DPT_Switch
87, 92, 97, 102, 107, 112, 117, 122	Logic Function X, Input 4	1 Bit	-WC---	[1.1] DPT_Switch
88, 93, 98, 103, 108, 113, 118, 123	Logic Function X, Output	1 Bit	R-CT--	[1.1] DPT_Switch

8.2 Alarms

Internal alarms are displayed through the alarm LED located on the front plate (version EK-HC1-TP only, please refer to the *Switching, connection and display elements* section). The last active alarm text description is stored in CO 83 - *Alarm text*: when an alarm goes active, a string "ALARM Exx" is issued, while when an alarm returns to normal a string "NO ALARM Exx" is issued. The following table shows the list of all error codes and descriptions.

Error code	Description
Error Code 06	Analog input 1: generic NTC failure
Error Code 07	Analog input 1: room temperature sensor failure
Error Code 08	Analog input 1: coil temperature sensor failure
Error Code 09	Analog input 1: delivery water temperature failure
Error Code 10	Analog input 1: outdoor temperature failure
Error Code 11	Analog input 1: antistratification temperature failure
Error Code 14	Analog input 2: generic NTC failure
Error Code 15	Analog input 2: room temperature sensor failure
Error Code 16	Analog input 2: coil temperature sensor failure
Error Code 17	Analog input 2: delivery water temperature failure
Error Code 18	Analog input 2: outdoor temperature failure
Error Code 19	Analog input 2: antistratification temperature failure
Error Code 22	Analog input 3: generic NTC failure (*)
Error Code 23	Analog input 3: room temperature sensor failure (*)
Error Code 24	Analog input 3: coil temperature sensor failure (*)
Error Code 25	Analog input 3: delivery water temperature failure (*)
Error Code 26	Analog input 3: outdoor temperature failure (*)
Error Code 27	Analog input 3: antistratification temperature failure (*)
Error Code 31	Outdoor temperature from bus failure
Error Code 32	Room temperature from bus failure
Error Code 33	Coil temperature from bus failure
Error Code 35	Delivery water temperature from bus failure
Error Code 37	Antistratification temperature from bus failure
Error Code 42	Outdoor temperature from bus timeout
Error Code 43	Room temperature from bus timeout
Error Code 44	Coil temperature from bus timeout
Error Code 46	Delivery water temperature from bus timeout
Error Code 48	Antistratification temperature from bus timeout
Error Code 50	Windows contact 1 from bus timeout
Error Code 51	Windows contact 2 from bus timeout
Error Code 52	Presence sensor 1 from bus timeout
Error Code 53	Presence sensor 2 from bus timeout
Error Code 56	Drip tray level sensor from bus timeout
Error Code 57	External regulator timeout

Table for error codes and alarm texts

(*) For EK-HC1-TP version

8.3 Application examples

The following figures show some application examples of the fan-coil actuator-controller EK-Hx1-TP.

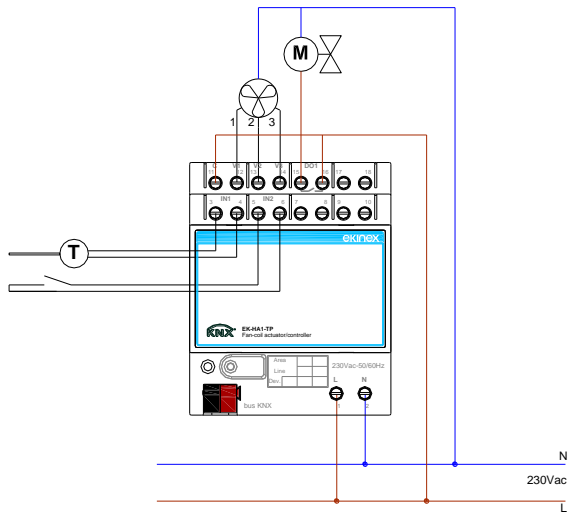
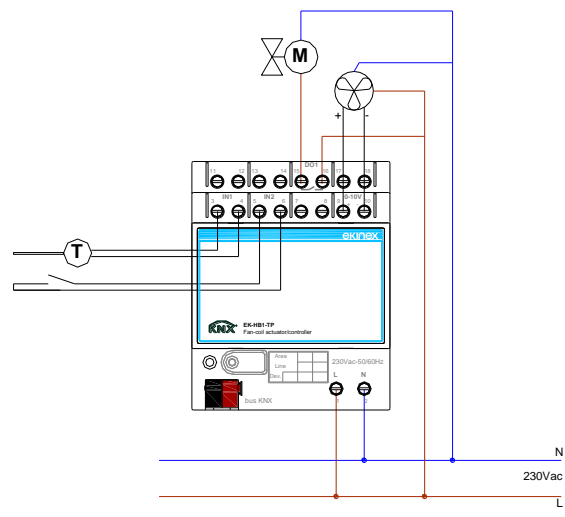
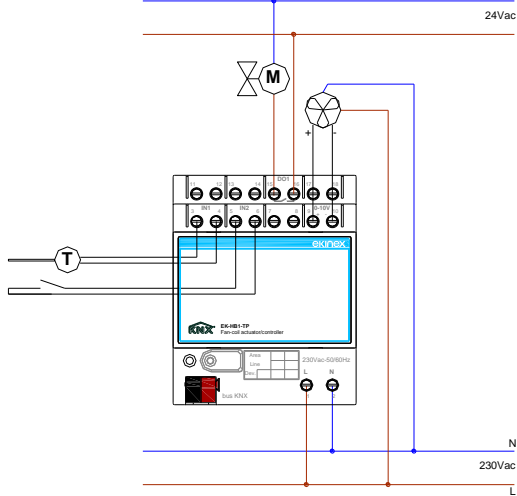
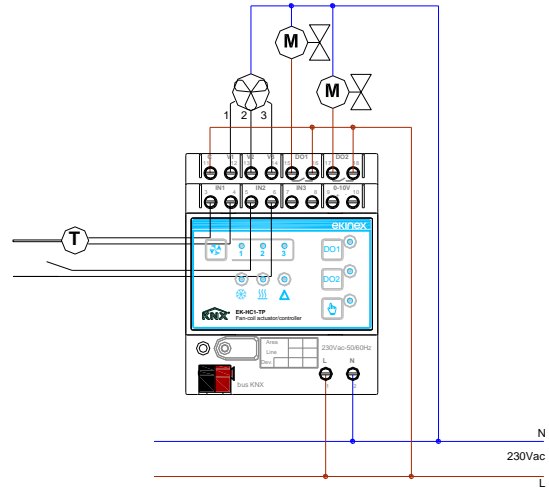
	
<p>EK-HA1-TP: 3 speeds discrete fan, 2 pipes system, basic application with internal controller and temperature sensor in environment or on return air. Pay attention to electric connections. V1, V2, V3 and DO1 outputs must be powered externally (terminal blocks 11-16) with power supply phase: in order for the system to work it is necessary to connect the other motor wire and the other actuator wire to the power supply neutral.</p>	<p>EK-HB1-TP: 0...10V fan, 2 pipes system, classic application as a simple actuator in combination with EK-EP2-TP or EK-EQ2-TP ekinex thermostats. The actuator on the oil can be powered at 24 Vac (refer to following schematics).</p>
	
<p>EK-HB1-TP: 0...10V fan, 2 pipes system, classic application for residential; actuator for intercept valve on the heat exchange coil powered at 24 Vac.</p>	<p>EK-HC1-TP: 3 speeds fan, 4 pipes system, complete application. The fan unit can be equipped with a brushless motor with 0...10V control. The actuators for intercept valve on heating and cooling coils are powered at 230 Vac.</p>

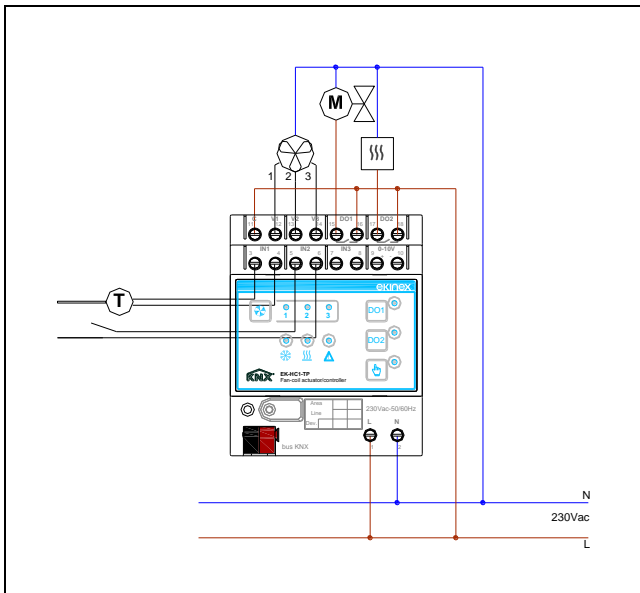

EK-HC1-TP: 3 speeds fan, 2 pipes system, complete application. In this case, the DO2 output (with 230Vac relays and 16A capacity) can be used to command an additional heating stage with electric coil.

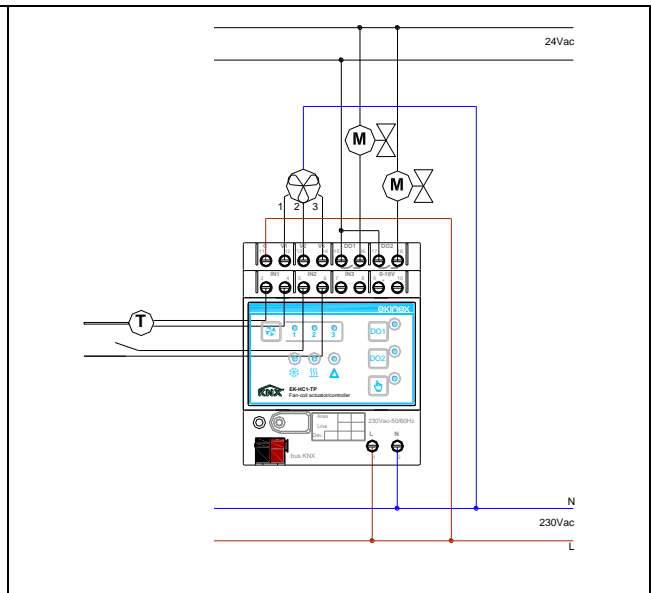

EK-HC1-TP: 3 speeds fan, 4 pipes system, complete application. The fan unit can be equipped with a brushless motor with 0...10V control. The actuators for intercept valve on heating and cooling coils are powered at 24 Vac.

9 Warnings

- Installation, electrical connection, configuration and commissioning of the device can only be carried out by qualified personnel.
- Opening the housing of the device causes the immediate end of the warranty period.
- ekinex® KNX defective devices must be returned to the manufacturer at the following address:
EKINEX S.p.A. - Via Novara 37, I-28010 Vaprio d'Agogna (NO) Italy.

10 Other information

- This application manual is aimed at installers, system integrators and planners
- For further information on the product, please contact the ekinex® technical support at the e-mail address: support@ekinex.com or visit the website www.ekinex.com
- KNX® and ETS® are registered trademarks of KNX Association cvba, Brussels

© EKINEX S.p.A. The company reserves the right to make changes to this documentation without notice.