

Actuators / controllers for fan_coil

Code : EK-HA1-TP / EK-HB1-TP / EK-HC1-TP



Data sheet STEKHC1TP_EN

KNX devices with function of actuator and temperature controller for convectors and fan-coil. To be used in KNX installations for control of homes and buildings.



Descrizione

The EK-Hx1-TP series includes three devices ekinex® KNX S-mode suitable for temperature control applications. The EK-HC1-TP is used for installations in 2 or 4-pipe hydraulic distribution systems with ON / OFF control of an electrothermal actuator on a shut-off valve; control of a 3-speed fan or 0-10 V control of a fan with brushless motor; this version allows manual control of the outputs through the membrane pushbuttons. The EK-HA1-TP version is used for installations in 2-pipe hydraulic distribution systems with ON / OFF control of an electrothermal actuator on a shut-off valve and a 3-speed fan. EK-HB1-TP version is used for installations in 2-pipe hydraulic distribution systems with ON / OFF control of an electrothermal actuator on a shut-off valve and 0-10 V control of a fan with brushless motor. The devices can be configured as actuators for the control of a fan and a maximum of two shut-off valves ON / OFF on the heat exchange coils , in combination with a room thermostat installed on the KNX network . The devices can be configured as controllers / actuators with acquisition of the temperature of a room sensor KNX or via a sensor installed on the return duct and connected to one of the analog inputs.

Functions

EK-HA1-TP

- Power supply from the bus and auxiliary power supply
- 230 Vac 50/60 Hz
- Control of 2-pipe hydraulic distribution systems with shutoff valve ON/OFF (1 SPST relay)
- 3 relay outputs to control a 3-speed fan
- 2 inputs freely configurable for acquisition of passive temperature sensors (10 kΩ NTC at 25°C) or as potential-free binary inputs

EK-HB1-TP

- Power supply from the bus and auxiliary power supply 230 Vac 50/60 Hz
- Control of 2-pipe hydraulic distribution systems with shutoff valve ON/OFF (1 SPST relay)
- 1 output 0-10 V for control of a fan with brushless motor
- 2 inputs freely configurable for acquisition of passive temperature sensors (10 kΩ NTC at 25°C) or as potential-free binary inputs

EK-HC1-TP

- Power supply from the bus and auxiliary power supply 230 Vac 50/60 Hz
- Control of 2 or 4-pipe hydraulic distribution systems
- With shutoff valve ON/OFF (2 SPST relays)
- Control of a 3-speed fan or 0-10 V control of a fan with brushless motor
- 3 inputs freely configurable for acquisition of passive temperature sensors (10 kΩ NTC at 25°C) or as potential-free binary inputs

Integrated Temperature Controller

- Settings via bus with Setpoint Setpoint single or related activated through the way HVAC System
- ON / OFF or PWM (pulse width modulation) of the water flow to the heat exchange coils
- ON / OFF at 1-3 windows with hysteresis or PI (Proportional Integral) of the air flow of the fan
- Switching heating / cooling from the bus or automatically according to the ambient temperature or according to the temperature of the fluid at discharge
- Ability to enable a compensation curve climatic cooling
- Automatic hot-start and cold -start the fan based on the actual temperature of the heat exchanger
- Trigger fan in case of stratification in large environments
- Function monitoring condensate level
- Monitoring function operating hours with signaling replacement filter

Technical Data

- Bus voltage KNX :29 Vdc
- Operating voltage : 230 Vac 50/60 Hz
- 3 Out for Fan relay (interlocked) with monostable relays (5A/230Vac), contacts with voltage and external power supply terminal (EK-HA1-TP and EK-HC1-TP version)
- 1 Out 0...10V for high impedance inputs (EK-HB1-TP and EK-HC1-TP version)
- 1 Out with monostable relay (5A/230Vac) SPST type single pole single throw, to control the valve of the thermal battery. Contact without voltage.(EK-HA1-TP ed EK-HB1-TP version)

- 1 Out with monostable relay (5A/230Vac) SPST type single pole single throw, to control the valve of the thermal battery. Contact without voltage(EK-HC1-TP version)
- Current consumption KNX bus:< 10 mA
- Plastic container
- Installatio type : board on EN 60715 DIN rail
- Protection rating: IP 20 in according with EN 60529
- Climate and mechanics classification : 3K5 and 3M2 in according EN50491-2
- Protection class III in according with EN 60664-1
- Pollution 2 in according with IEC 60664-1
- Dimension : 72 x 90 x 60 mm (LxHxP)

Enviromental Conditions

- Operating temperature: - 5 ... + 45°C
- Storage Temperature: - 25 ... + 55°C
- Transport Temperature: - 25 ... + 70°C
- Relative Humidity : 95%

Switching, display and connection elements

All devices are equipped with a button , a LED programming, KNX terminals for connecting the outputs, additional line voltage and KNX bus line. The EK-HC1-TP version is equipped with membrane buttons and LEDs.

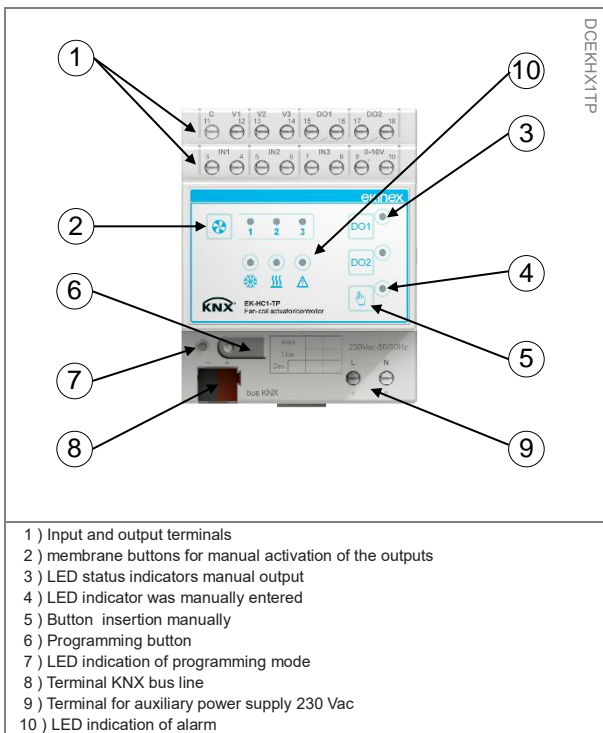

Command Elements

- Pushbutton (6) for switching between the normal operation mode and programming
- Membrane pushbutton (5) for switching between the operating modes forced (buttons on the front active) or automatic (buttons on the front non-active)
- Membrane pushbuttons (2) for forcing the fan speed

Thanks to the lever switches located on the front of the device, the connected loads can be manually controlled in the absence of voltage on the KNX bus or when the programming has not yet been carried out.



Note. For the version with membrane keyboard EK- HC1 - TP , the manual control of the terminal is possible if the voltage is present both on the KNX bus that the mains voltage

Display elements

- Red LED (7)for displaying the active operating mode of the device (on = programming, off = normal operation)
- Red LED (4) for indicating the operating mode (on = forced operation , off = automatic)
- Green LEDs for status indication of the speed set manually for the fan and for the manual setting of the output valves
- Red LED (10) to give the status of alarm

Mounting

The device has degree of protection IP20, and is therefore suitable for use in dry interior rooms.

The housing is made for rail mounting according to EN 60715 in boards or cabinets for electrical distribution.

The installation is in horizontal position, the correct position is when the KNX bus terminal is located at the bottom and the terminals for the outputs are located at the top.

For the installation of the device on the rail proceed as follows:

- with the aid of a tool bring the locking device in the fully lowered position (1);
- place the upper edge of the rear inner profile on the upper edge of the rail (2);
- rotate the device towards the rail (3);
- push the locking device upward until it stops (4).

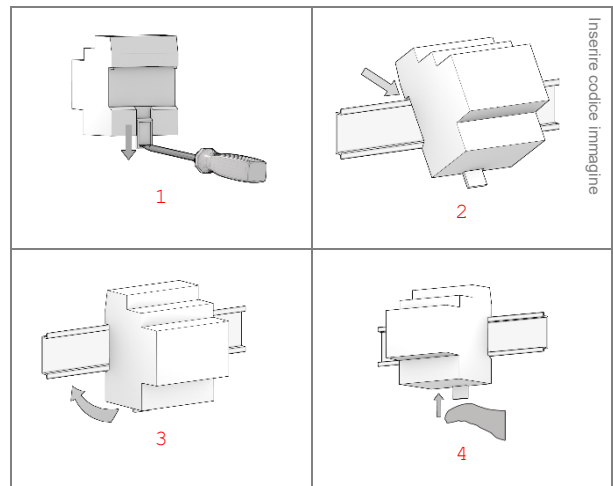

Before removing the device, be sure the inputs have been disconnected and the bus terminal has been extracted from its slot. Use a screwdriver to slide down the locking device and remove the device from the rail.



Note. For the EK-HC1-TP version it is recommended that the installation of the device always ensure the full accessibility of the front side to allow the operation of the pushbuttons

Connection of the KNX bus line

The connection of the KNX bus line is made with the terminal block (black/red) included in delivery and inserted into the slot of the housing.

Characteristics of the KNX terminal block

- spring clamping of conductors
- 4 seats for conductors for each polarity
- terminal suitable for KNX bus cable with single-wire conductors and diameter between 0.6 and 0.8 mm • recommended wire stripping approx. 5 mm
- color codification:
red = + (positive) bus conductor
black = - (negative) bus conductor



Warning! In order to supply the KNX bus lines use only a KNX bus power supply (e.g. ekinex EK-AB1-TP or EK-AG1-TP). The use of other power supplies can compromise the communication and damage the devices connected to the bus.

Connection of the 230 Vac line (all version)

The connection of the line is made with screw terminals located on the upper front of the device.(Figure A).

Characteristics of the terminals

- screw clamping of conductors
- maximum cross section of conductor 2.5 mm² (single wire)
- recommended wire stripping approx. 6 mm
- torque max 0.8 Nm



Warning! The electrical connection of the device can be carried out only by qualified personnel. The incorrect installation may result in electric shock or fire. Before making the electrical connections, make sure the power supply has been turned off..

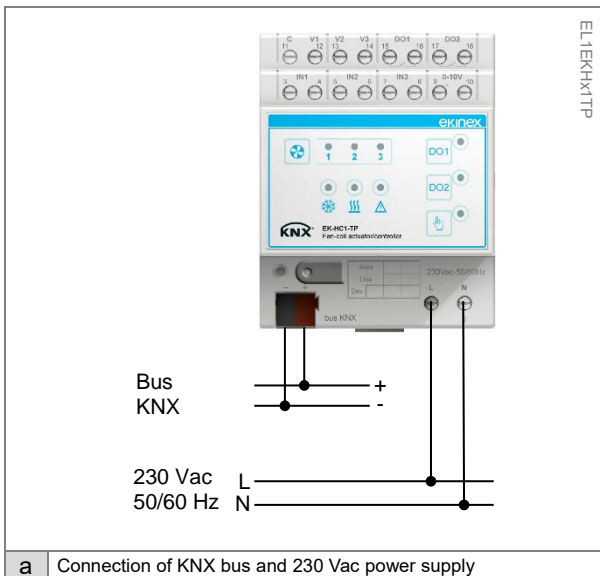

Inputs/ Outputs Terminal

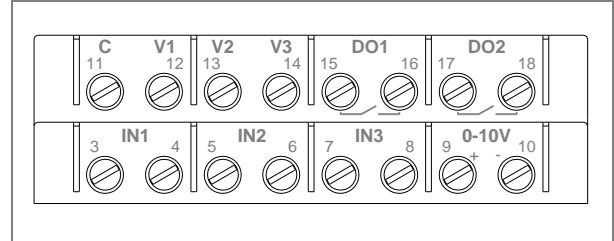

Terminals	Name	Signal Type
3-4	IN1	Input 1 configurable as passive probe temperature (sensor NTC 10kΩ @ 25 °C) or as a binary input (potential free)
5-6	IN2	2 freely configurable input
7-8	IN3	3 freely configurable input (only EK - HC1 - TP)
9-10	0-10V	Output 0 ... 10V (for high impedance inputs) to control the fan with brushless motor (for EK - HB1 - TP and EK - HC1 - TP)
11	C	common Input to control 3-speed motor (for EK - HA1 - TP and EK - HC1 - TP)
12	V1	Relay output fed to control the fan speed 1 (for EK - HA1 - TP and EK - HC1 - TP)
13	V2	Relay output fed to control the fan speed 2 (for EK - HA1 - TP and EK - HC1 - TP)
14	V3	Relay output fed to control the fan speed 3 (for EK - HA1 - TP and EK - HC1 - TP)
15-16	DO1	Potential free relay output to control actuator valve heat exchange
17-18	DO2	Potential free relay output to control actuator valve heat (only EK - HC1 - TP)

The outputs that are not used for the command of the terminal temperature control can be configured in ETS for the control of actuators of lighting or drive .

Example

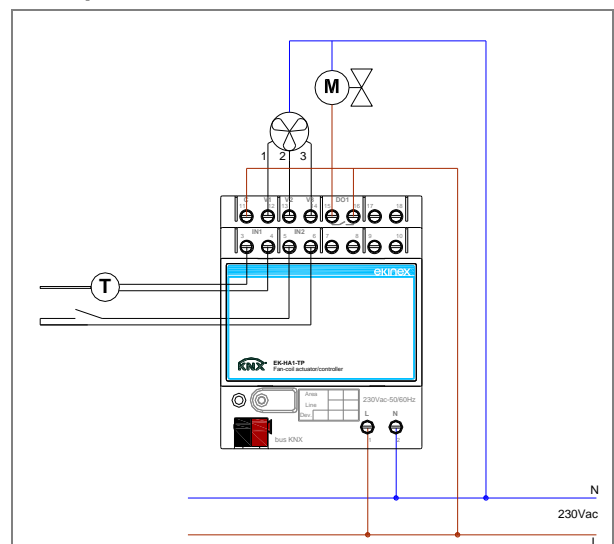

EK-HA1-TP:

3-speed fan, 2-pipe system, application with use of the internal regulator and room sensor or on the recovery. attention to the electrical connections. The outputs V1, V2, V3 and C1 must be powered externally (terminals 11 and 15) with the power phase: because the system functions you must connect the other end of the motor fan and the other end of the actuator to the conductor neutral.

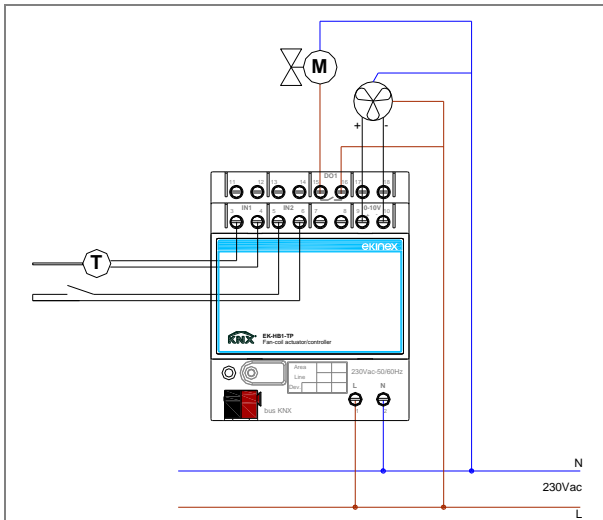

EK-HB1-TP:

Fan 0...10V , 2-pipe system,application for residential; the product can be used as a simple actuator in combination with the thermostat ekinex EK - EP2 - TP or EK - EQ2 - TP. The actuator on the battery can be of the 24 Vac (diagram below).

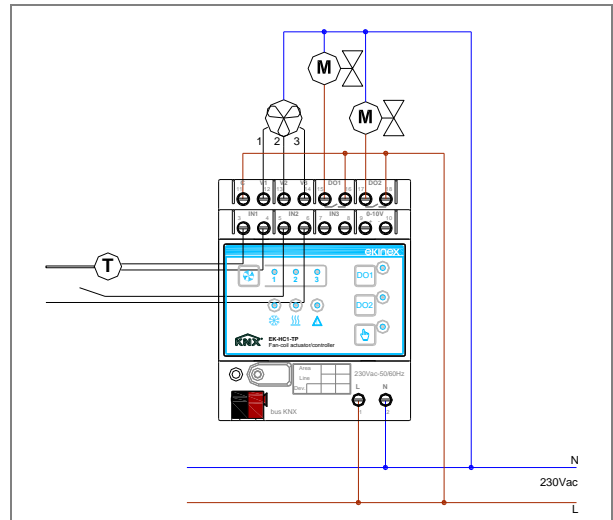

EK-HC1-TP:

Fan 3-speed, 4-pipe system , complete application. The fan can also be a brushless motor with 0...10V. Actuators for shut-off valves of the batteries warm and cold water supplied at 230 Vac.

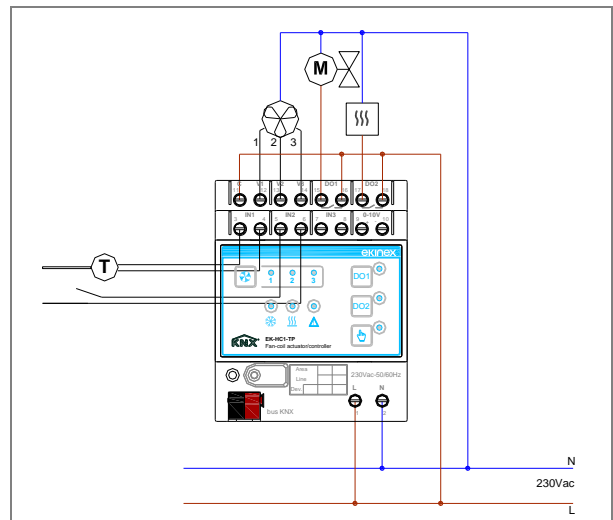

EK-HC1-TP:

3-speed fan, 2-pipe system, complete application. In this case the output DO2 (with relay 230 Vac and ability 16A) can be used to control an additional stage of heating with electric battery.

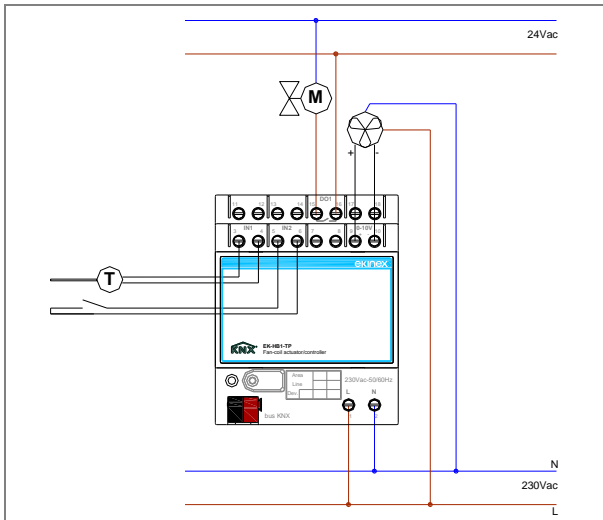

EK-HB1-TP:

Fan 0...10V, 2-pipe system, application for residential; actuator valve for exchange battery powered at 24 Vac .

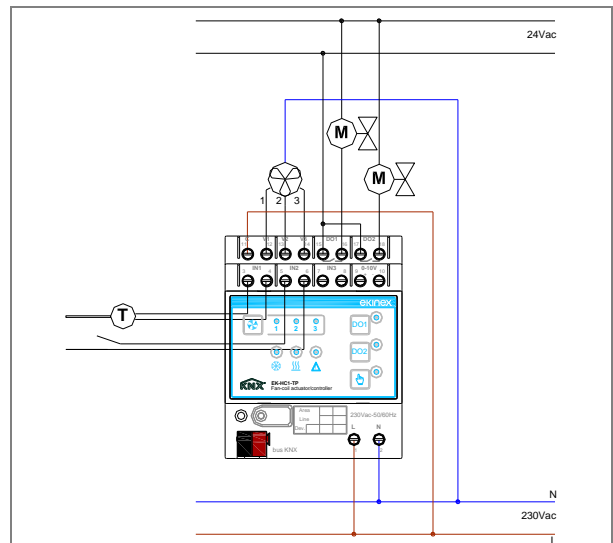

EK-HC1-TP:

Fan 3-speed, 4-pipe system , complete application. The fan can also be a brushless motor with 0...10V. Actuators for shut-off valves supplied at 24 Vac of the batteries warm and cold water.

Configuration and commissioning

Configuration and commissioning of the device require the use of the ETS® (Engineering Tool Software) program V4 or later releases. These activities must be carried out according to the design of the building automation system done by a qualified planner. Configuration For the configuration of the device parameters the corresponding application program or the whole ekinex® product database must be loaded in the ETS program.

For detailed information on configuration options, refer to the application manual of the device available on the website www.ekinex.com

Product code	Application software (## = version)	Communication objects (max nr.)	Group addresses (max nr.)
EK-HA1-TP	APEKHA1TP##.knxprod	45	254
EK-HB1-TP	APEKHB1TP##.knxprod	45	254
EK-HC1-TP	APEKHC1TP##.knxprod	63	254



Note. The configuration and commissioning of KNX devices require specialized skills. To acquire these skills, you should attend the workshops at KNX certified training centers.

Commissioning

For commissioning the device the following activities are required:

- make the electrical connections as described above;
- turn on the bus power supply;
- switch the device operation to the programming mode by pressing the programming pushbutton located on the front side of the housing. In this mode of operation, the programming LED is turned on;
- download into the device the physical address and the configuration with the ETS® program.

At the end of the download the operation of the device automatically returns to normal mode; in this mode the programming LED is turned off. Now the bus device is programmed and ready for use.

Dimensions [mm] (All versions)

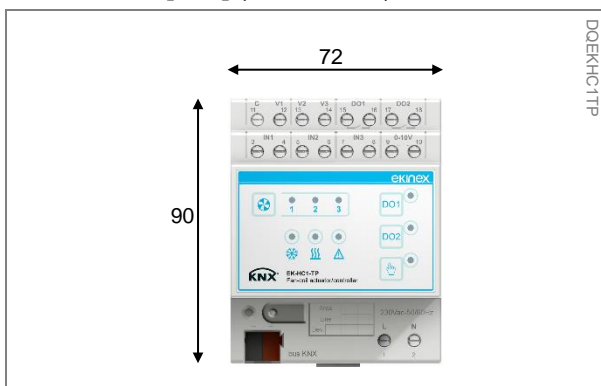

Marks



the device complies with the Low Voltage Directive (2006/95/EC) and the Electromagnetic Compatibility Directive (2004/108/EC).

Tests carried out according to EN 50491-2:2010, EN 50491-3:2009, EN 50491-4 - 1:2012, EN 50491-5-1:2010, EN 50491-5-2:2010, EN 50428:2005 +A1:2007 + A2:2009

Maintenance

The device is maintenance-free. To clean use a dry cloth. It must be avoided the use of solvents or other aggressive substances.



Disposal

At the end of its useful life the product described in this datasheet is classified as waste from electronic equipment in accordance with the European Directive 2002/96/EC (WEEE), and cannot be disposed together with the municipal undifferentiated solid waste.



Warning! Incorrect disposal of this product may cause serious damage to the environment and human health. Please be informed about the correct disposal procedures for waste collecting and processing provided by local authorities.

Documentation

This datasheet refers to the release A1.0 of the ekinex® devices EK-HA1-TP, EK-HB1-TP and EK-HC1-TP, and is available for download at www.ekinex.com as a PDF (Portable Data Format) file.

Filename	Device release	Updating
STEKHx1TP_EN.pdf	A1.0	01/2016

Warnings

- Installation, electrical connection, configuration and commissioning of the device can only be carried out by qualified personnel in compliance with the applicable technical standards and laws of the respective countries
- The use of the device in security applications is not allowed. The device may however be used for auxiliary signaling functions
- Opening the housing of the device causes the immediate end of the warranty period
- In case of tampering, the compliance with the essential requirements of the applicable directives, for which the device has been certified, is no longer guaranteed
- ekinex® KNX defective devices must be returned to the manufacturer at the following address: EKINEX S.p.A. Via Novara 37, I-28010 Vaprio d'Agogna (NO) Italy Other information
- This datasheet is aimed at installers, system integrators and planners
- For further information on the product, please contact the ekinex® technical support at the e-mail address: support@ekinex.com or visit the website www.ekinex.com
- KNX® and ETS® are registered trademarks of KNX Association cvba, Brussels

© EKINEX S.p.A. The company reserves the right to make changes to this documentation without notice.